

6390031

Model 631, 639

EuroTwin Drink Center

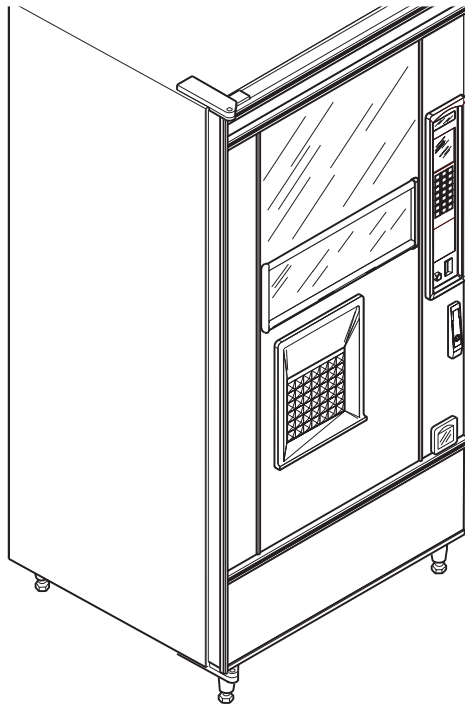

Operators' Guide

CRANE REPLICAMARK SYSTEMS A Crane Company
NATIONAL VENDORS

12955 Enterprise Way
Bridgeton, Missouri 63044-1200
(314) 298-3500
www.nationalvendors.com

Copyright© 7-01

6390031

This machine has been engineered to our own rigid safety and performance standards. It has been designed to comply with sanitation and health guidelines recommended by the Automatic Merchandising Health-Industry Council (AMHIC) and it conforms with all other NAMA safety recommendations.

This machine has been manufactured in accordance with the safety standards of both Underwriter's Laboratories and the Canadian Standards Association. To maintain this degree of safety and to continue to achieve the level of performance built into this machine, it is important that installation and maintenance be performed so as to not alter the original construction or wiring and that replacement parts are as specified in the *Parts and Service Manual*. Your investment in this equipment will be protected by using this *Operator's Guide* and the *Parts and Service Manual* in your operation, service and maintenance work. By following prescribed procedures, machine performance and safety will be preserved.

Table of Contents

Initial Set-up	1
Power Requirements	1
Water Requirements	1
Water Pressure	1
Supply Line Requirements	1
Flushing The Water Supply Line	1
Positioning The Merchandiser	2
Final Installation	2
Connect The Merchandiser To The Water Supply	2
Connect The Merchandiser To The Power Source	2
Level The Merchandiser	3
Set Up The Menu Assembly	4
Install Options	5
Install The Coin Box Lock	5
Mount The Base Plate Brackets	5
Mount The Base Plate And Slides	6
Install The Water Filter Cartridge	7
Get The Machine Ready To Vend Drinks	8
Set Up The Co2 Tank	8
Fill The Hot Water Tank	8
Load The Cup Mechanism	9
Load And Set Up Hot Drink Products	10
Adjustments And Minor Maintenance	11
Emptying The Bill Stacker	11
Adjusting The Air Pressure Control (Model 639 Only)	11
Cup Mechanism Adjustment	12
Hot Water Valve Adjustment	13
Cold Water Valve Adjustment	13
View A	13
View B	13
Syrup Pump Adjustment	14
Canister Installation	15
Programming	16
How To Program Your Eurotwin	16
The Displays	17
The Function Keys	17
Other Keys	17
Control Panel Switch Functions Explained	18
Programming Flowcharts	19
Programming Procedures	23
Gain Access To The Supervisor Mode	24
Enter A New Supervisor Code	24
Enter A New Freevend Code	24
Lock Or Unlock Mode Or Payout Keys	25
Set Printer Or Dex Options	25
Lock Or Unlock Data Clearing Access	26
Assign A Code To View Data Without Opening The Door	26
Select Printer Baud Rate (Printer Mode Only)	27

EUROTWIN OPERATOR'S GUIDE

Select Bill Validator And Options	28
Select Card Reader And Options	29
Select Coin Mechanism And Options.....	30
Select Monetary Options	31
Select Display Language	32
Set Up Winner Mode	33
Set Up Mug Discount.....	34
Set Up Machine Configuration Options (Supervisor Mode Only)	34
Identify The Active Selections In The Merchandiser (Supervisor Only).....	36
Set Up Cup Sizes.....	36
Set Up A Hot Drink	38
Collecting Dry Product Gram Throws.....	40
Collecting Hot Water Throws.....	43
Set Up A Cold Drink.....	45
Collecting Cold Water And Syrup Throws	46
View Software Version	46
Set Hot And Cold Temperature	47
Set The Automatic Brewer Rinse Time (Brewer Equipped Machines Only)	48
Set The Automatic Mixing Bowl Rinse Time	49
Set The Time Of Day.....	50
Set The Day Of The Week.....	50
Set Month, Day, And Year	50
Set Time-of-day Inhibited Vending	51
Set Time-of-day Free Vending.....	51
Set Time-of-day Discount Vending.....	51
Time Interval Editing	52
Select A Standby Message.....	54
Select An Out-of-service Message.....	54
Select A Freevend Message	55
Edit Custom Messages.....	56
The End Of Message Character.....	56
Entering Your Message.....	57
View Water Tank And Cold Plate Temperature	58
View Machine Configuration Setting.....	58
Payout Coins.....	59
Set Prices.....	60
Set Entire Machine To One Price	60
Set The Price Of An Individual Selection	60
Set All Cup Sizes To One Price	60
Set All Sizes Of A Selection To One Price	61
View Nonresettable Sales And Vend Data.....	61
View Data Three Different Ways	62
View Total Paid Sales	62
View Total Paid Vends	62
Clear All Resettable Data	63
Clear Paid Sales Data Only.....	63
View Amount In Coin Box (Not Shown If Zero)	63
View Amount In Validator (Not Shown If Zero).....	64
View Freevend Sales By Time Interval (Not Shown If Zero).....	64
View Discount Sales By Time Interval.....	64

EUROTWIN OPERATOR'S GUIDE

View Free Vends (Not Shown If Zero)	65
View Winners (Not Shown If Zero)	65
View Time Data	66
View Total Unpaid Sales	67
View Total Unpaid Vends	67
View Number Of Test Vends (Not Shown If Zero).....	67
View Number Of Mug Vends (Not Shown If Zero)	67
View Machine Id Number	68
Test Vend Selections And Verify Credit Added	68
Test The Display	68
Test Drop A Cup	69
Test The Whipper(s).....	69
Test The Air Compressor	69
Test The Brewer	70
Rinse The Mixing Bowls.....	70
Rinse The Brewer.....	70
Purge The Carbonator	71
Clear Tank Errors And Fill The Tank	71
Test Switches Or Sensors	71
View Diagnostic Messages	72
Download Data To A PDCD.....	74
Set Freevend Options	74
Cleaning And Sanitation	75
Basics	75
Overall Cleaning.....	77
Preventive Maintenance Cleaning	77
Cleaning Procedures	77
Sanitation Procedures	78
Appendix A. The Infrared Mug/cup Sensor	A-1
Appendix B. Modify Canister To Vend 12 Oz. Cups.....	B-1
Appendix C. Clean The Hot Water Tank.....	C-1
Appendix D. The Free Vend Keyswitch Option.....	D-1

THIS PAGE IS INTENTIONALLY LEFT BLANK

INITIAL SET-UP

I. POWER REQUIREMENTS

This merchandiser requires power as shown in the following table. NOTE: Each merchandiser should have its own electrical circuit

Power Requirements

Country	Volts	Frequency (Hz)	Current (Amps)
Canada	115	60	15
France	230	50	10
Germany	230	50	10
United Kingdom	230	50	10
United States	115	60	15

II. WATER REQUIREMENTS

The best type of water for coffee brewing is normal hard water. If your location has chemically softened water, one of the following steps is advised:

- Have a non-softened supply line run to the merchandiser
- Contact your local water filter supplier for information and suggestions

Well water can also be used in the EuroTwin Machine. However, you should have it checked for levels of carbonates and alkalies. Contact your water filter supplier if these values are relatively high.

WATER PRESSURE

- Minimum water pressure: 20 psi (138.0 KPa) at 1/2 gallon/minute
- Maximum water pressure: 80 psi (522.0 KPa) at 1/2 gallon/minute

SUPPLY LINE REQUIREMENTS

- Locate the supply line at the rear of the merchandiser.
- Equip the line with a shut-off valve.

FLUSHING THE WATER SUPPLY LINE

Flush the water supply line before connecting it to the merchandiser. A minimum of five gallons is usually required before connecting the merchandiser to the supply line. DO NOT flush the merchandiser water system to avoid introducing possible water line contaminants into the merchandiser.

EUROTWIN OPERATOR'S GUIDE

III. POSITIONING THE MERCHANDISER

You can position this merchandiser anywhere in a bank of machines. It can even be placed on the end flush against a side wall.

Leave enough room in front of the merchandiser for the door to move freely.

BE SURE THE REAR OF THE MERCHANDISER IS AT LEAST 6" AWAY FROM THE WALL. THIS WILL ENSURE WARM MOIST AIR IS VENTED OUT OF THE MACHINE'S INTERIOR AND THE REFRIGERATOR CONDENSER FAN IS NOT OBSTRUCTED.

WARNING

THIS MACHINE IS ONLY RATED FOR INSTALLATION IN AN INDOOR LOCATION.

IV. FINAL INSTALLATION

1. CONNECT THE MERCHANDISER TO THE WATER SUPPLY

- a. You will need the following:
 - A coil of copper tubing with outside diameter of 3/8 inch (9.5 mm) or greater. The appropriate plastic tubing may be substituted.
 - A 3/8 inch (9.5 mm) flare fitting
- b. Connect the merchandiser to your water supply.

2. CONNECT THE MERCHANDISER TO THE POWER SOURCE

Power to the merchandiser is controlled by the main power switch, located on the power panel.

- a. Make sure the main power switch is OFF.
- b. Connect the merchandiser's power cord to your wall outlet.

3. LEVEL THE MERCHANDISER

- a. Place a spirit level on the top front edge of the cabinet with the door fully closed. Adjust the front legs only until the cabinet is reasonably level.
- b. Hold the door open about 4 inches.

WARNING

HAVE AN ASSISTANT HOLD THE MERCHANDISER WHILE YOU ADJUST THE LEG LEVELERS.

- c. Adjust the back legs so that the back leg leveler on the hinge side is off the floor just enough so a piece of paper can slide under it with only a bit of resistance.
- d. For proper weight distribution on all four legs, raise the back leg on the hinge side by unscrewing the leveler $1\frac{3}{4}$ turns.

NOTE

You may need to use pliers or channel locks to loosen the leg levelers.

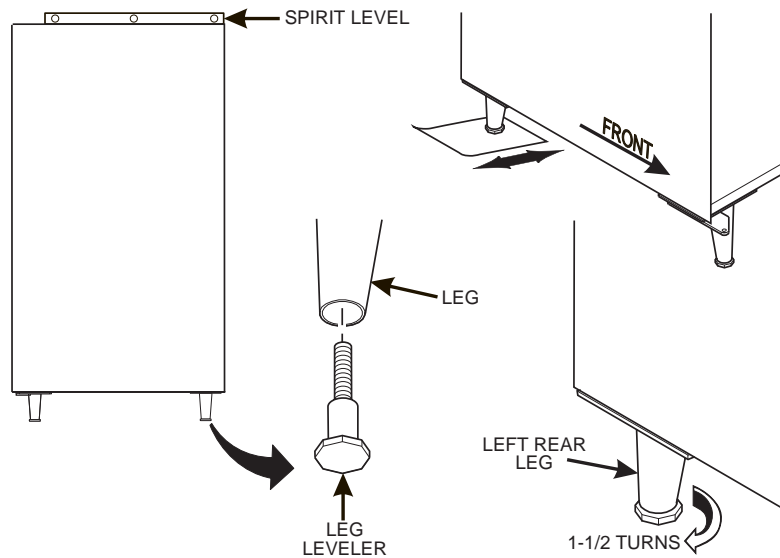

EUROTWIN OPERATOR'S GUIDE

4. SET UP THE MENU ASSEMBLY

- a. From the inside of the door, remove the two screws as indicated, and remove the end cap as shown.
- b. Loosen the remaining 10 screws as indicated 1/2 turn. **Do not loosen the screws any more than necessary to avoid stripping out the menu frame.**
- c. Remove the menu board. If it is still held too tightly, repeat step 6.
- d. Set up the menu board as desired and reinstall it in the reverse order of disassembly.

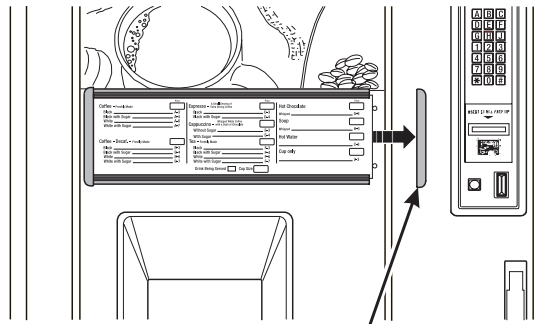

REMOVE THE MENU BOARD
END CAP AND SLIDE OUT THE
MENU BOARD.

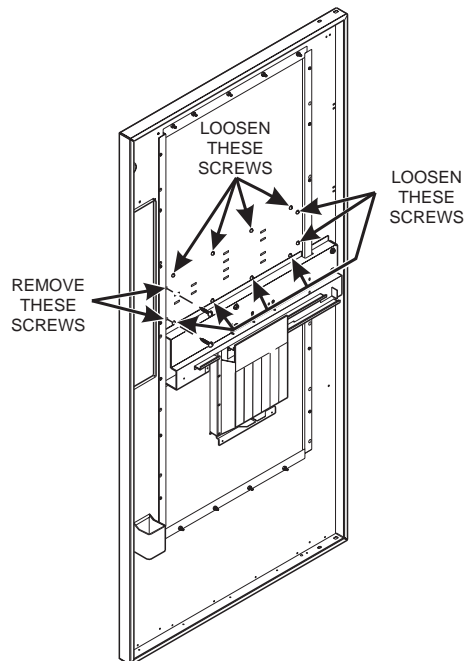

V. INSTALL OPTIONS

1. INSTALL THE COIN BOX LOCK

- a. Install the lock cylinder, washer, and nut in the order shown.
- b. Tighten the nut.
- c. Install the lock bar as shown, and secure with the screw.

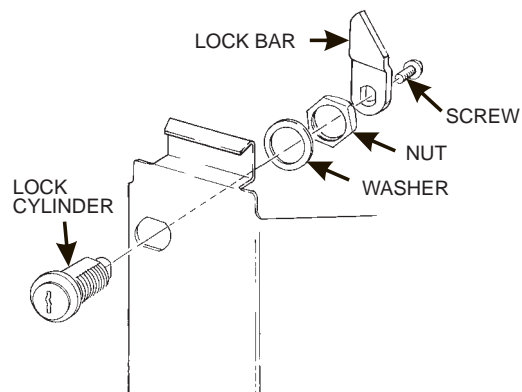

2. MOUNT THE BASE PLATE BRACKETS

- a. Secure a base plate bracket at each of the remaining pairs of holes with two of the hex head screws.

EUROTWIN OPERATOR'S GUIDE

3. MOUNT THE BASE PLATE AND SLIDES

- a. Insert the short arm of the slides into the hinged tabs of the base plate. Position the slide so the notch near the short arm is on the bottom side.
- b. Insert the long arms of the slides into the base plate brackets.
- c. Insert a cotter pin through the hole in the back end of each slide. Secure the pins in place.
- d. Push the base plate toward the merchandiser cabinet. The front tab of the base plate bracket should seat in the notch in the long arm of the slide.

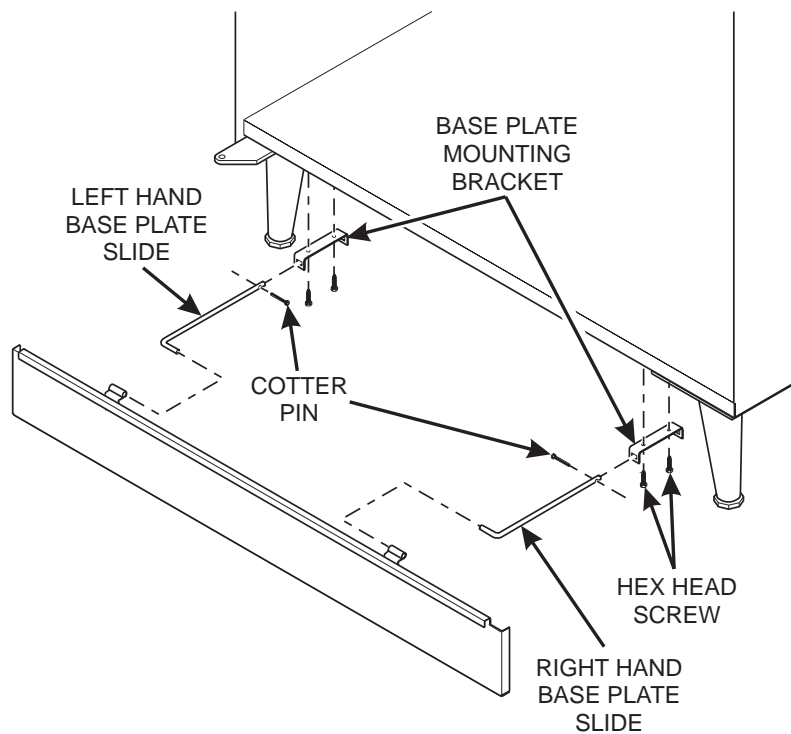

CAUTION

The mounting brackets are subject to damage when moving the machine with a fork lift.

Remove the brackets prior to moving the machine with a fork lift to prevent damage.

4. INSTALL THE WATER FILTER CARTRIDGE

IF YOUR MERCHANDISER HAS THE WATER FILTER OPTION, IT CANNOT BE OPERATED WITHOUT A PROPERLY INSTALLED WATER FILTER CARTRIDGE.

NOTE

Check the water filter installation record. There is a place to write the vend number on the cartridge. The cartridge is effective for a maximum of 26,000 7 oz. vends, 22,000 8 oz. vends, 20,000 9 oz. vends, or 15,000 12 oz. vends. Local conditions may require more frequent replacement.

- a. Your filter cartridge is shipped inside the waste pail. Locate it and remove the wrapping.
- b. Remove the liquid waste pail (if present) to gain access to the water filter head assembly, located at the right rear of the machine.
- c. Install the filter as shown.

TO INSTALL FILTER:

- 1. ALIGN RAISED RIB ON FILTER CARTRIDGE WITH MATING SLOT IN HEAD ASSEMBLY.
- 2. FIRMLY INSERT FILTER CARTRIDGE INTO HEAD ASSEMBLY AND ROTATE COUNTER-CLOCKWISE 1/4 TURN TO THE STOP.
- 3. OPEN THE WATER SHUT-OFF VALVE BY PUSHING THE HANDLE TO THE HORIZONTAL POSITION AS SHOWN BELOW.

TO REMOVE FILTER:

- 1. CLOSE THE WATER SHUT-OFF VALVE BY LIFTING THE HANDLE TO THE VERTICAL POSITION AS SHOWN BELOW.
- 2. ROTATE THE FILTER CLOCKWISE AND PULL DOWN AS SHOWN.

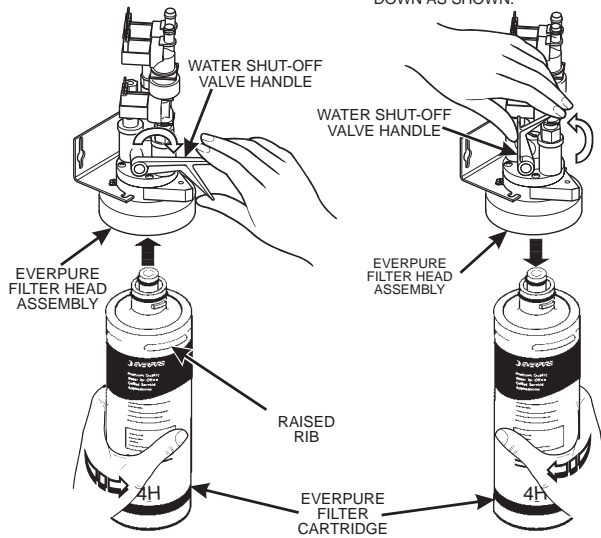

EUROTWIN OPERATOR'S GUIDE

VI. GET THE MACHINE READY TO VEND DRINKS

1. SET UP THE CO₂ TANK

- a. Place the power switch in the OFF position.
- b. Install a full CO₂ tank on the floor area in front of the cooling unit.
- c. Remove the CO₂ tank lid.
- d. Locate the CO₂ regulator and flat plastic washer (in a box), and the tapered plastic washer (in plastic bag).
- e. Insert the tapered washer into the flare nut of the CO₂ line connected to the unit.
- f. Using two wrenches, tighten the line to the regulator.
- g. Insert the flat washer into the regulator nut.
- h. Using two wrenches, connect the regulator to the tank outlet and tighten in place.



WARNING:

Not using a wrench on the tank side may damage the CO₂ tank, resulting in personal injury.

- i. Open CO₂ tank valve.
- j. Adjust the CO₂ regulator so that the secondary gauge reads 5.50 bar (80 PSI).
- k. Lock the adjustment screw in place.
- l. Remove the cooling machine cover and actuate the pressure relief valve located on top of the carbonator tank for 3 to 5 seconds.
- m. Check for gas leaks along the CO₂ line.

2. FILL THE HOT WATER TANK

If you have the water filter option and **HAVE NOT** yet installed the water filter, return to step 7 and install the filter as instructed.

- a. Turn on the water at its source.
- b. Check for any water leaks.
- c. Turn the machine power switch ON. The carbonator pump will start automatically and will fill the carbonator with water.
- d. Press .
- e. Press  until the display shows **TANK.FILL**.
- f. Press  again and let water flow into the tank.
- g. The display will show **FILLING TANK**. After the tank is filled the display will show **TANK.FILL**.

EUROTWIN OPERATOR'S GUIDE

NOTE

The tank will take some time to fill and reach its operating temperature.

- h. If this is the first time that the tank is being filled, perform the tank cleaning procedure given in Appendix C.

3. LOAD THE CUP MECHANISM

CAUTION

Use only cups which have been designed for use in a hot beverage vending machine.

The size of cup you load must agree with the cup size that you will select during programming.

- a. Support the cup mechanism in the upright position.
- b. Push the latch forward to release the cup mechanism. Continue to support the cup mechanism while you lower it into the loading position.
- c. Remove the turret cover.

OBSERVE PROPER HYGIENE - DO NOT TOUCH THE CUPS!

- d. Open the bottom of the wrapper on a stack of cups.
- e. Insert the wrapped cups into the turret and pull the wrapper out.

DO NOT FILL CUPS ABOVE THE LEVEL MARKED ON THE OUTSIDE OF THE CUP TURRETS OR ABOVE THE "FILL LINE" LABEL INSIDE EACH TURRET, OR MOTOR JAMS WILL OCCUR.

USE ONLY THE SAME SIZE AND BRAND OF HOT DRINK CUPS IN EACH TURRET; DO NOT INTERMIX!

- f. Replace the turret cover after the turrets have been loaded.
- g. Be sure the cup mechanism is locked into the upright position.

TURRET DESIGNATIONS

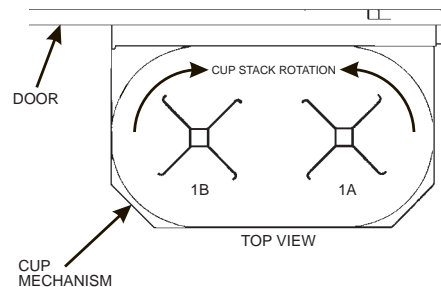

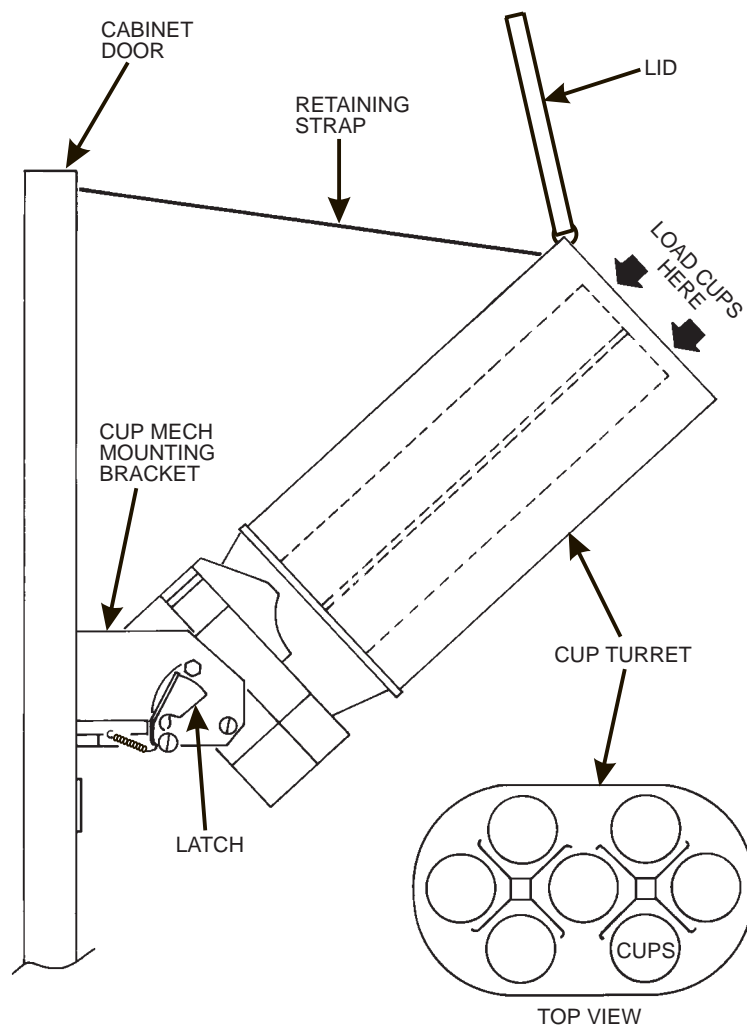

4. LOAD AND SET UP HOT DRINK PRODUCTS

- a. Fill each canister with its respective product.
- b. Once the hot water tank has reached its operating temperature, perform test vends (see **COLLECTING DRY PRODUCT GRAM THROWS** and **COLLECTING HOT WATER THROWS**). Adjustments may be necessary to water, product, or condiment throw times, or to the hot water valves. Refer to the appropriate sections in this manual for instructions on how to do this.

ADJUSTMENTS AND MINOR MAINTENANCE

EMPTYING THE BILL STACKER

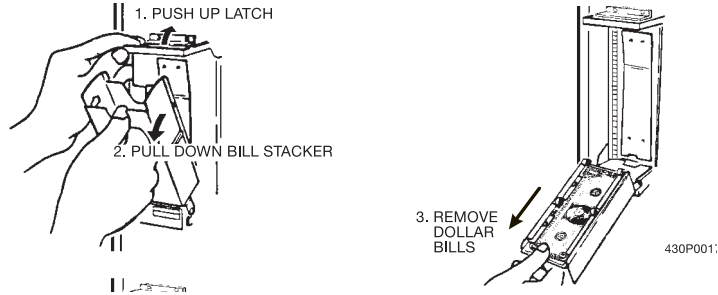

ADJUSTING THE AIR PRESSURE CONTROL (MODEL 639 ONLY).

This control determines the system pressure provided by the air compressor. Adjust the pressure as follows:

- With the compressor running, pinch the brewer inlet air tube.
- Adjust the pressure to read 10 - 12 psi on the gauge.

This will produce a pressure of 3 - 6 psi using regular coffee and 8° oz cups. No further air pressure adjustments should be necessary.

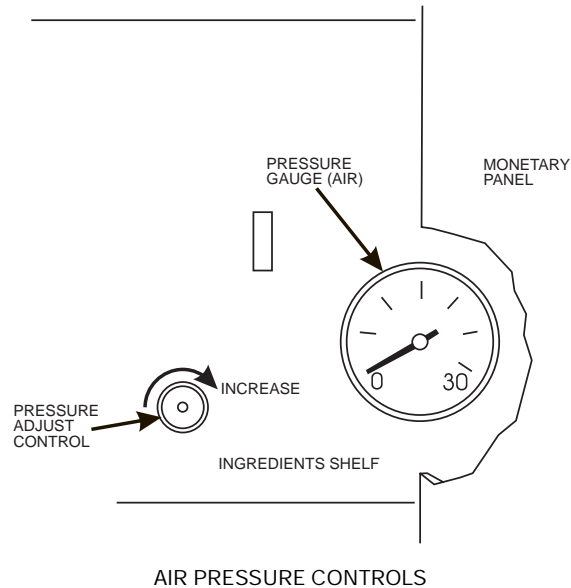

EUROTWIN OPERATOR'S GUIDE

CUP MECHANISM ADJUSTMENT

1. Place seven cups in the cup ring.
2. Observe the clearance as shown in view B.
3. If necessary adjust by first loosening the adjustment arm screw (view A).
4. Move adjustment arm until correct clearance is achieved.
5. Hold adjustment arm in place and tighten adjustment arm screw.

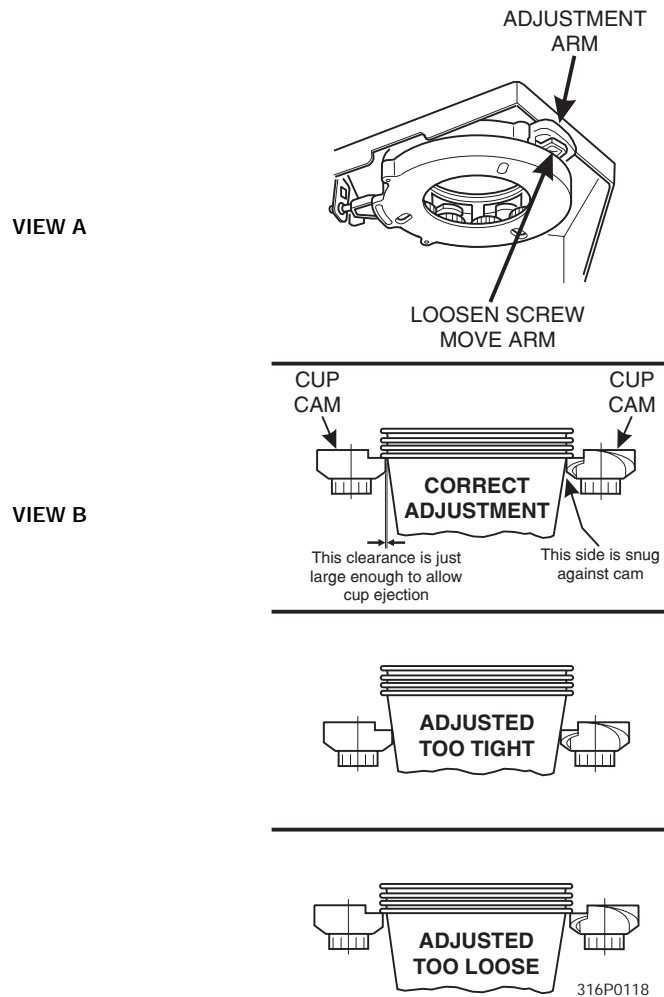

HOT WATER VALVE ADJUSTMENT

The hot water valves do not usually require adjustment, but in some cases adequate water volume cannot be achieved by the throw time setting alone (see the programming section). **IF ABSOLUTELY NECESSARY**, adjust the valves in conjunction with setting the factory default timers.

1. Using a slotted screwdriver, turn the adjustment screw clockwise to decrease the water flow rate.
2. Turn the adjustment screw counterclockwise to increase the water flow rate.

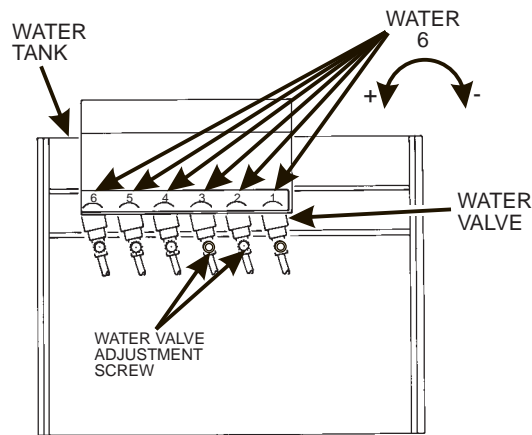

COLD WATER VALVE ADJUSTMENT

Cold water valves do not usually require adjustment, but in certain cases adequate water volume cannot be achieved by adjusting the throw time setting alone (see the programming section). **IF ABSOLUTELY NECESSARY**, ADJUST THE VALVES IN CONJUNCTION WITH SETTING THE TIMERS.

1. Turn the carbonated water adjustment screw counterclockwise (CCW) until it stops in the fully open position. Do not force it to stop the flow because it is not a positive closure system.
2. Turn it clockwise (CW) 3 full turns.
3. Turn the non-carbonated water adjustment screw CCW until it stops. Do not force it to stop the flow because it is not a positive closure system.
4. Turn it back clockwise (CW) 1 full turn.

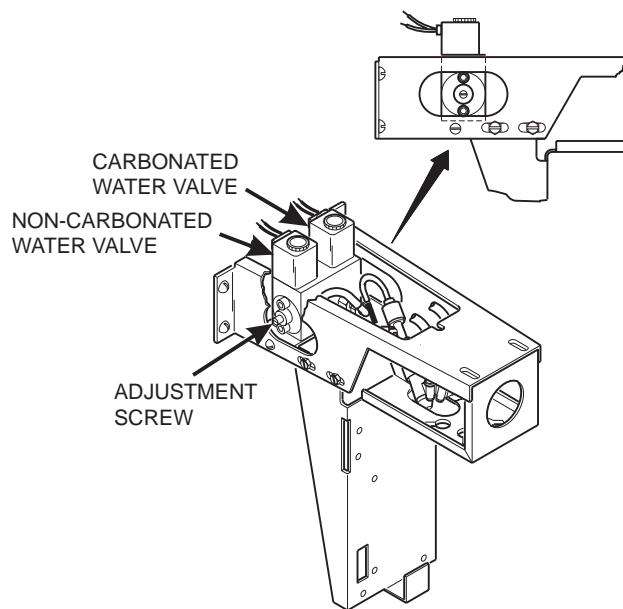

SYRUP PUMP ADJUSTMENT

The syrup pumps do not usually require adjustment, but in some cases adequate volume cannot be achieved by the throw time setting alone (see the programming section). IF ABSOLUTELY NECESSARY, ADJUST THE VALVES IN CONJUNCTION WITH SETTING THE FACTORY DEFAULT TIMERS.

1. Loosen the locknut on the syrup pump adjustment screw.
2. Turn the screw clockwise (CW) until it is flush with the upper face of the locknut.
3. Turn the screw counterclockwise (CCW) 3 full turns.
4. Tighten the locknut to secure the screw.
5. Repeat steps 1 through 4 for the other syrup valve.

CANISTER INSTALLATION

1. Place the canister in position as shown.
2. Engage the pins on the motor shaft with the slots in the canister coupler.
3. Fit tabs on canister into the slots on the canister shelf.
4. To ensure canister is correctly engaged with the rear mounting bracket, gently push down on the front edge of the canister lid.

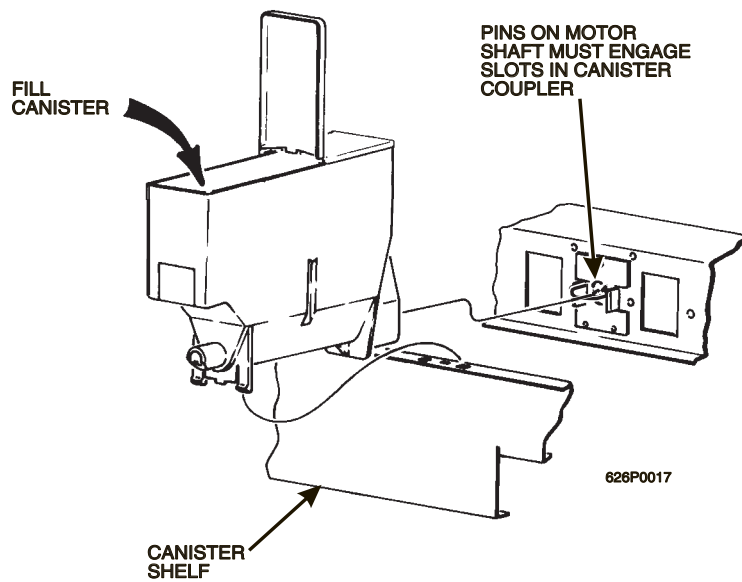

PROGRAMMING

HOW TO PROGRAM YOUR EUROTWIN

Some setup, test, and maintenance operations are computer controlled. The control panel switches (see figure 1) and the selection panel switches (see figure 2) regulate these operations.

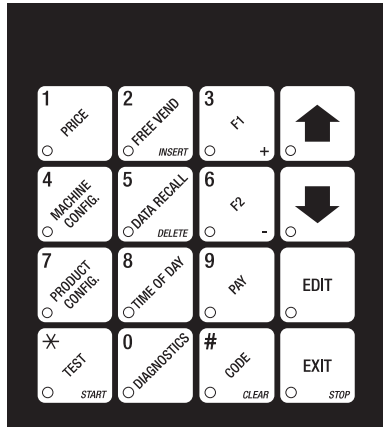

Figure 1. Control Panel

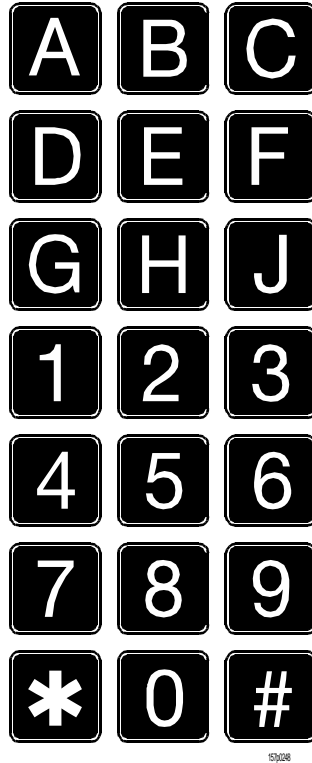

Figure 2. Selection Panel

THE DISPLAYS

The 10-character display performs two functions, and is referred to in this book as "the display":

1. It shows the customer's selection and how much credit is in the machine, as well as the ready, service, and time of day messages.
2. It provides information and feedback to the service person during maintenance.



THE FUNCTION KEYS

The keys on the control panel can be used for up to three things:

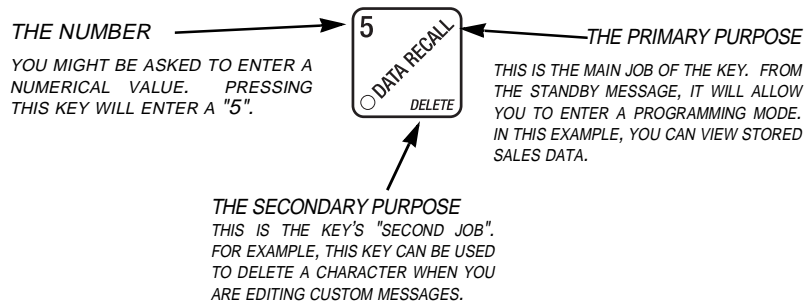

OTHER KEYS

The **MOVEMENT** keys on the control panel let you move inside a mode, and back and forth between modes. To see how these keys let you move around, study the flow diagram on the next page.



The up and down arrow keys are your "legs", which let you move up and down the list of tasks. These keys are what let you con-
tinue from one step to the next in programming procedures.



This is your "activate" or "choose" key. It "opens a door" to additional information and lets you begin a programming task once you are inside of a mode. Sometimes, it is used as a toggle switch to show you your choices during a programming task.



This is your "end" key. Pressing it one or more times will move you back to the start of the mode, or all the way back to the standby message.

EUROTWIN OPERATOR'S GUIDE

CONTROL PANEL SWITCH FUNCTIONS EXPLAINED

Each of the control panel switches has one or more jobs to do. This list will give you a short overview of those jobs..



Press this button to put your machine into the Price Setting mode. You can see maximum and minimum machine prices, and change prices for entire machine or individual selection.



Press this button to set up how the Free Vend mode will operate.



Press this button to view the water tank and cold plate temperatures, software version number, machine configuration, and active selection status.



Press this button to:

- Select display language
- Select coin mechanism and options
- Select bill validator and options
- Set winner feature



Press this button to view total sales and vends by whole machine, selection, or drink size. Clear resettable data.



Press this button to:

- Download data into your portable data collection device (PDCD), **OR**
- Set printer baud rate, depending upon which device you are using



Press this button to:

- Set machine configuration
- Set up drinks
- Set which selections are active
- Set cup size
- Select sanitation and rinse times
- Set tank temperature



Press this button to:

- Set time of day
- Set day, month, year
- Set up time of day intervals for inhibit, freevend, and discount vending
- Select display messages
- Edit messages



Press this button to pay one or more coins from the coin mechanism.



Allows you to see any fault or condition that has placed the machine out of service



Press this button to:

- Perform TEST VENDS
- Test machine functions
- Test displays
- Fill the water tank



Press this button to:

- Enter the SUPERVISOR mode
- Change the SUPERVISOR access code
- Lock and unlock access to functions

PROGRAMMING FLOWCHARTS

The flowcharts on the following pages will provide you with a "map" to the different programming features of your machine. Once you are familiar with the detailed programming steps given later in this section, you can use the flowcharts as a shortcut. Each chart begins with the key you will use to access those steps. Follow the lines and arrows from one step to another. A rectangular box contains the functions or tasks you will perform at that point. Sometimes, you have to make a decision. For example, look at the MACHINE CONFIGURATION chart. At one point, you are asked to select your monetary options (coin mech, bill validator, etc.). Depending upon your choice, you will take a different path. Note that if you have no mech, no validator, and no card reader, you bypass a whole lot of other options and are taken right to the winner selection screen. Just follow the lines and arrows, and you will get through it.

Machine Configuration

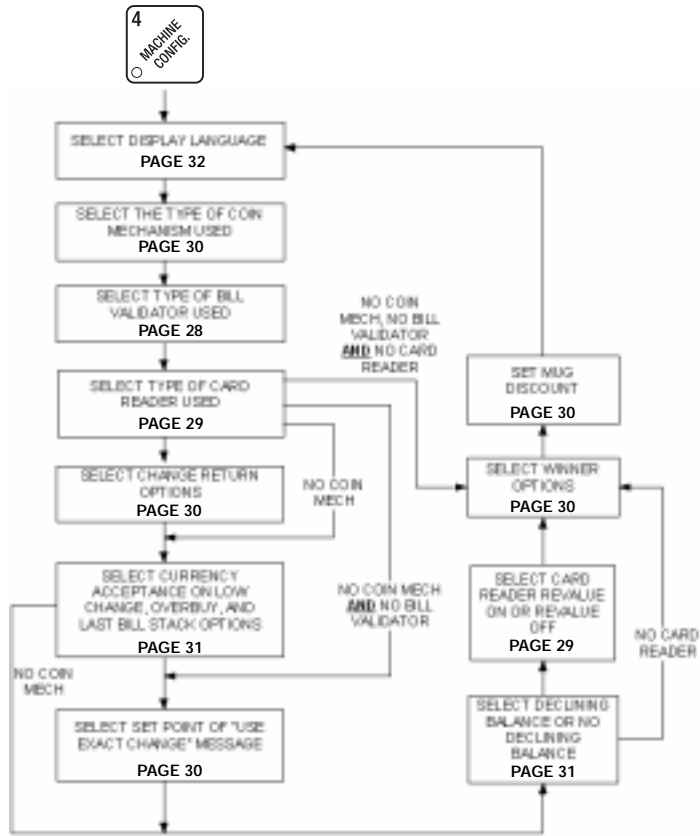

Payout Coins

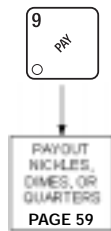

Free Vend

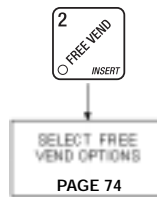

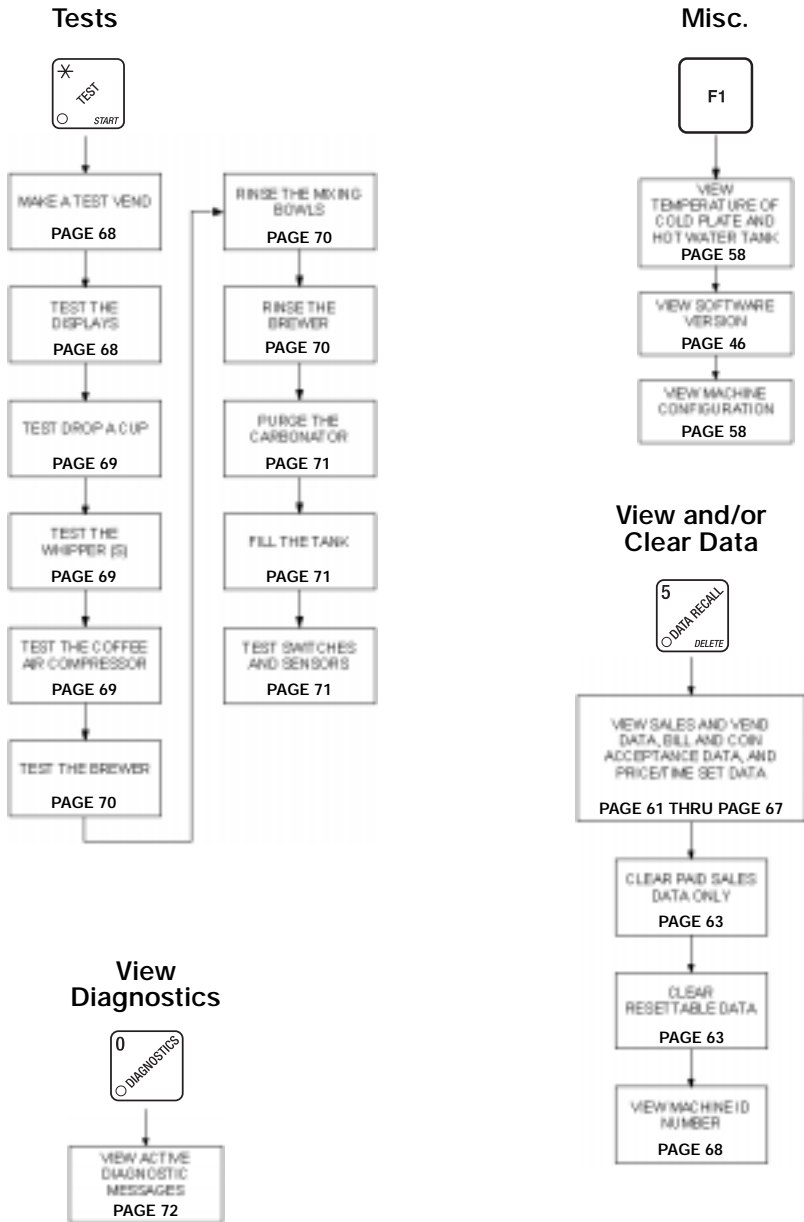

Time of Day Supervisor Functions Product Configuration

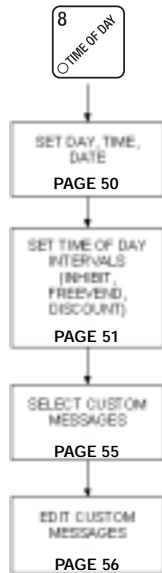

Pricing

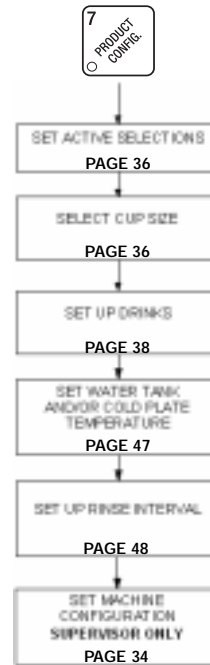
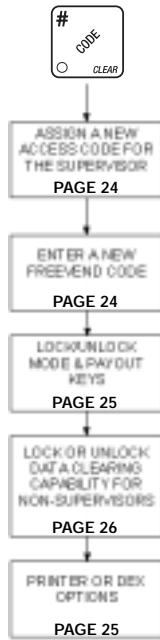

DEX/Printer

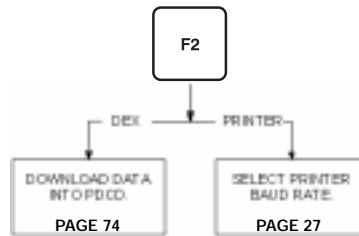

PROGRAMMING PROCEDURES



The pages that follow contain all the programming steps you will need for the EuroTwin merchandiser. Each procedure is presented so that it "stands alone". This means that you can look up a procedure, go directly to it, perform the procedure, quit the procedure then go on about your business.

However, after looking at the programming flowcharts, you should notice that several

procedures are grouped under each mode key (such as ) , and you can move between them by using the up and down arrow keys. Therefore, you don't have to exit a procedure before performing another one.

Most procedures respond to you the same way, like how to enter, leave, and move around inside them. Here is a short guide to help you through these common steps:

- To move directly from one procedure to another (provided they are both grouped

under the same mode key), use  and .

- When you are finished with a function, you will want to CONTINUE. To do that, you can press  (you may have to press it more than once, depending on how far into a procedure you are). You can then perform another programming or maintenance function. If you are completely done with maintenance, just shut the merchandiser door.

- Text that looks like this: *DISPLAY* represents what you will see in the display on the monetary panel.
- Definitions and helpful information will appear in shadow boxes:

EUROTWIN OPERATOR'S GUIDE





GAIN ACCESS TO THE SUPERVISOR MODE

1. Press . The display shows: *ENTER CODE*. You must enter the four-digit supervisor code within 6 seconds to gain access.

NOTE

A new machine has a factory-set supervisor code of 0000.

When you have entered the right code, you will hear two beeps and see *UNLOCKED* in the display. After a few moments, the standby message returns.

2. At the standby message, press , then . You are now ready to perform various supervisor functions.



ENTER A NEW SUPERVISOR CODE

1. If you already entered your supervisor code, skip to step 3. If not, follow the steps in **GAIN ACCESS TO SUPERVISOR MODE**, then return here.

IMPORTANT

If you enter a new code, be sure to keep a written record of it. There is no other way to access the SUPERVISOR mode.

3. Press  until the display shows *SUPERXXXX*. The X's represent the current supervisor code. Use the number keys to enter a new code.
2. CONTINUE.



ENTER A NEW FREEVEND CODE

1. If you already entered your supervisor code, skip to step 4. If not, follow the steps in **GAIN ACCESS TO SUPERVISOR MODE**, then return here.
4. Press  until the display shows *FREEXXXX*. The X's represent the current freevend code. Use the number keys to enter a new code.

NOTE

See Appendix D for more information on the freevend keyswitch.

2. CONTINUE.



LOCK OR UNLOCK MODE OR PAYOUT KEYS

1. If you already entered your supervisor code, skip to step 1. If not, follow the steps in **GAIN ACCESS TO SUPERVISOR MODE**, then return here.

1. Press  until the display shows either *X. LOCKED* or *X. UNLOCKED*. "X" refers to the number or character shown on the mode or payout key in question (1 through 9, # and *). To see if a key is locked or unlocked, press that key.

2. Press  to change between locked and unlocked. When anyone other than the supervisor tries to enter a locked mode, the display shows *LOCKED*.

NOTE

The following mode keys cannot be locked out:



2. CONTINUE.
-



SET PRINTER OR DEX OPTIONS

1. If you already entered your supervisor code, skip to step 3. If not, follow the steps in **GAIN ACCESS TO SUPERVISOR MODE**, then return here.

3. Press  until the display shows one of the following:

PRINTER means that data will be sent directly to a printer,
OR

DEX ONLY means that data remains in memory after it is downloaded into a portable data collection device,
OR

DEX CLR means that resettable data is cleared after it is downloaded into a portable data collection device.



4. Press  to switch between the three choices.

2. CONTINUE.



LOCK OR UNLOCK DATA CLEARING ACCESS

1. If you already entered your supervisor code, skip to step 2. If not, follow the steps in **GAIN ACCESS TO SUPERVISOR MODE**, then return here.

1. Press  until the display shows either *#. LOCKED* or *#. UNLOCKED*.
LOCKED means that non-supervisors cannot clear resettable machine sales and vend data from the  key.

2. Press  to switch between *#. LOCKED* and *#. UNLOCKED*.

NOTE

The supervisor can clear data regardless of this setting, provided the supervisor code was correctly entered first.

2. CONTINUE.
-



ASSIGN A CODE TO VIEW DATA WITHOUT OPENING THE DOOR

If the proper code is entered, sales and vend data can be viewed without opening the machine's door.



1. Follow the steps in **GAIN ACCESS TO THE SUPERVISOR MODE**.
2. Press  until the display shows *NR XXXX*. The X's represent the currently entered code. Use the number keys to enter a new code, if desired.
3. CONTINUE.



SELECT PRINTER BAUD RATE (PRINTER MODE ONLY)

BAUD RATE

The speed of data transfer, expressed in bytes per second. Your printer can receive data at a certain rate, and you must tell the machine what that rate is.

1. Press . One of the following is displayed:
BAUD 1200 BAUD 2400 BAUD 4800 BAUD 9600
1. Press  until the correct baud rate for your printer is displayed.
2. CONTINUE.



SELECT BILL VALIDATOR AND OPTIONS

1. Press , then press  until one of the following is displayed:

NO DBV

No bills will be accepted or there is no bill validator installed (you can exit the function).

SER.1.2.5.10.20

The serial bill validator is selected and will accept \$1, \$2, \$5, \$10, and \$20 bills. Use BILL SELECTION METHOD below to change the bills which will be accepted.

MDB.1.2.5.10.20

A standard MDB bill validator is selected. It will accept \$1, \$2, \$5, \$10 and \$20 bills. Use BILL SELECTION METHOD below to change the bills which will be accepted.

*MDB. < * >*

An MDB bill validator which accepts non-standard bills or tokens is connected and operating. Press  to enter list of bills. (See **INITIAL SETUP OF NON-STANDARD BILL VALIDATOR** on the following page.)

BILL LIST OPERATION:

Use  and  to scroll through the list of bills.

Use  to turn the bill acceptance ON or OFF.

Use  to move up to the top level screen.

- 1. 1.00 ON* - 1. = Bill validator channel 1, each bill has its own channel
1.00 = Bill value
ON = \$1.00 bill will be accepted
- 1. 1.00 OFF* - OFF = \$1.00 bill will not be accepted
- TKN* - Token bills (same as coupon bills)

INITIAL SETUP OF NON-STANDARD BILL VALIDATOR:
Connect the bill validator, select MDB in the bill validator selection screens. The standard *MDB.1.2.5.10.20* screen will appear first. Exit the bill validator setup by pressing



. Bill information is now collected from the validator. Re-enter the bill validator selection screen and the non-standard screen "*MDB. <*>*" will appear.

PULSEDBV



The pulse bill validator will accept \$1 bills.

Press  to choose the desired option.

2. CONTINUE.



SELECT CARD READER AND OPTIONS

1. Press , then press  until the current card reader is shown in the display. Press  to choose the desired card reader.

2. CONTINUE.YOUR CHOICES ARE: *NO CARD, DUMB CARD, OR MDB CARD.*

NOTE

If you selected NO CARD you can exit the function.

1. Press  until one of the following is displayed:

REVALUE.ON - Allows credit to be transferred onto the card

REVALUE.OFF - Credit cannot be transferred to the card





Press  to display the desired choice.

3. CONTINUE.

EUROTWIN OPERATOR'S GUIDE



SELECT COIN MECHANISM AND OPTIONS

1. Press , then press  until the current COIN MECHANISM is shown in the display. Press  to choose the desired coin mechanism.
Your choices are: *DUMB MECH*, *MOB MECH*, *EXEC MECH*, or *NO MECH*.
2. Press  until the display shows *CHANGE X.XX*.
Coins and bills which are less than or equal to this value will be returned without a purchase being made.
Examples:
CHANGE 0.00 - Forced vend; NO change returned without a purchase.
CHANGE .25 - Nickels, dimes, and quarters returned without purchase.
CHANGE 1.00 - \$1 bills and SBAs will be returned as change without purchase. Nickels, dimes, and quarters are also returned.
3. Press  until the display shows: *LOW.MSG X.XX*. The display will show *USE EXACT CHANGE* when the amount of available change in the coin mechanism falls below the value of "X.XX". Enter a value with the number keys. For example, if *LOW.MSG 1.00* is displayed, the *USE EXACT CHANGE* message is displayed when less than a dollar's worth of change is in the coin mechanism.
4. CONTINUE.



SELECT MONETARY OPTIONS

This function lets you:

- Set declining balance,
- Set currency acceptance on low change,
- Set overbuy options,
- Set last bill stacking options

DECLINING BALANCE Once credit is established, multiple vends may occur until the coin return is pressed.

1. Press , then press  until one of the following is displayed:

DECLINE.ON - More than one vend is allowed, with a declining balance.

OR

DECLINE.OFF - A declining balance is not allowed.

Press  to display the desired choice.

1. Press  until one of the following is displayed:

ACC < \$\$X.XX - The last bill which meets or exceeds maximum price will be held in escrow.

OR

ACC.STKX.XX - The last bill which meets or exceeds maximum price and MDB coupon bills (token bills) will be immediately stacked.

Example: If setting is **ACC.STK1.00** and maximum price is \$1.50. This setting will immediately stack the second \$1.00 bill inserted.

Press  to display the desired choice.

The value of "X.XX" has two purposes:

- The value of "X.XX" tells the machine how big a bill or coin to accept even though there is not enough change in the coin mech to cover all possible paybacks.
- For example, enter **1.00**. Therefore, the machine will take a dollar bill or coin even though there is less than \$1.00's worth of change. Entering 5.00 tells the machine to take a five even though there is less than \$5.00's worth of change, and so forth.

NOTE: This could cause a customer to be short-changed.

EUROTWIN OPERATOR'S GUIDE

- Entering **0.00** means that bills or coins will only be accepted if there is enough change to cover them.
- b. The value of "X.XX" tells the machine how much the customer is allowed to overbuy a product. The customer will be short-changed when an overbuy occurs.

Example:



For a value of \$0.25: if there is no change in the machine and the customer inserts a \$1.00 bill. The customer can purchase a product for \$0.75 even though the change cannot be paid back. The customer will be short-changed. Normally a purchase will not be approved unless all change can be paid.

Entering 0.00 means that the vend will only be approved when the correct change can be returned (overbuy disabled).

2. CONTINUE.



SELECT DISPLAY LANGUAGE

1. Press . The current LANGUAGE is shown in the display. Press .

to choose the desired language. Your choices are: *ENGLISH, DEUTSCH, FRANCAIS, ESPANOL, PORTUGUES, NEDERLANDS, or SWEDISH.*

2. CONTINUE.



SET UP WINNER MODE

WINNER At preselected intervals, a customer may receive a refund for a selection. You can select the intervals and qualifying selections.

1. Press , then press until one of the following is displayed:

WINNER OFF Winner function is disabled.

OR

WINXXX Winners are allowed at certain intervals, represented by "XXX".

Press to display the desired choice.

If you selected *WINNER OFF*, you can exit the function.

1. The display shows *WIN XXX*. XXX represents the number of vends which must occur per each winner vend. For example, an interval number of 50 means that a winner can happen any one time during the next 50 vends. Using the number keys, enter an interval number between 10 and 9999.
2. Press . The display shows * ----- . The dashes in the display

represent which selections are allowed winners. Press the appropriate letter key to enable a selection, press the key again to disable it. For example, pressing **A**, **C**, and **E** will cause the display to look like this: *A-C-E-----*, meaning that all **A**, **C**, and **E** selections can have a winner.

ADVANCED OPTIONS:

- Press to enable all selections.
- Press to deactivate all selections.
- Press **0** or **1** to enable winners by cup size.

AN EXAMPLE . . .



- You want to enable winners on all selections except E and F. Do the following:
- a. Press **.** The letters **A** through **J** appear in the display instead of the dashes.
 - b. Press "E" and "F". The letters **E** and **F** in the display are replaced by dashes.

2. CONTINUE.



EUROTWIN OPERATOR'S GUIDE

SET UP MUG DISCOUNT

You can establish a discount for customers who use their own mug.

1. Press , then press  until the display shows *MUGDSC .00*. This example shows the existing discount amount is zero.
 1. Enter a discount amount. This will be in cents, for example press  or 5 to enter a discount amount of 5 cents.
 2. CONTINUE.
-

SET UP MACHINE CONFIGURATION OPTIONS (SUPERVISOR MODE ONLY)

1. Press  then  until the display shows *D- J- WXYZ*.
 - "D" is the current status of the automatic delivery door. A dash (-) means the automatic door is turned off; a plus sign (+) means the door is turned on. Press to turn the door ON OR OFF.
 - "J" is the current status of the whippers. A plus sign (+) means drinks will not be whipped unless the J key is pressed during the vend. A dash (-) means drinks **WILL** always be whipped **unless** the J key is pressed during the vend. Press J to switch back and forth between these two choices.
 - "WXYZ" is the machine configuration code, explained as follows:

Machine Type Configuration

Enter for (W)	Definition
1	Reserved for alternate use
2	EuroTwin

Soup and Sugar Substitute Configuration

Enter for (X)	Definition
1	Canister 5 is not used
2	Canister 5 contains sugar substitute
3	Canister 5 contains soup
4	Canister 5 contains topping mix

::

SINGLE BREW	A machine with only one brewed selection (the second selection is freeze-dried).
DUAL BREW	A machine with two brewed selections.

Brewer Configuration

Enter for (Y)	Definition
1	Single brew - coffee or leaf tea (Model 639)
2	Dual brew - Coffee and decaf coffee (Model 639)
3	Freeze dry only - no brewer (Model 631)

Canister Mapping (See figure below)

Enter for (Z)	Menu Selection Letters for Canister Numbers		
	3 (single condiment only)	2	1
1	F	B	A
2	F	A	B
3	B	F	A
4	B	A	F
5	A	F	B
6	A	B	F



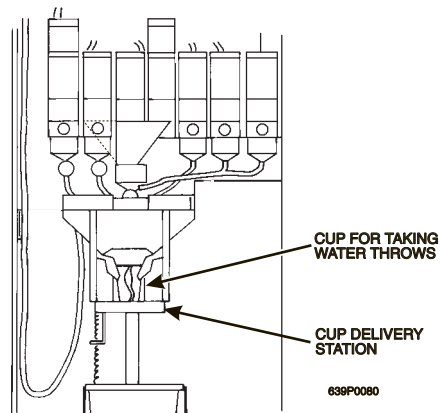

INDEX: A = Coffee B = Decaf F = Tea



EUROTWIN OPERATOR'S GUIDE



IDENTIFY THE ACTIVE SELECTIONS IN THE MERCHANDISER (SUPERVISOR ONLY)

1. Press , then press  until the display shows something like this:
0. ABCDEFGH. This display means that all regular size selections (0A - 0H) are available for vending. An unavailable selection has its letter replaced by a blank space.
1. Press the appropriate letter to toggle the display on or off.
2. Press  to display cold selections for this size (*0. ---5689*).
3. Press  to view the active selections for the large size cup.

NOTE





Unconfigured selections will not appear in the product setups or diagnostics.

2. CONTINUE.
-



SET UP CUP SIZES

This machine is capable of vending two different drink sizes, even though there is only one size cup loaded. For example, if you have 10 ounce cups in your machine, you can vend any two available drink sizes **UP TO AND INCLUDING** 10 ounces. Make sure that the cups you have loaded are physically larger than the selected sizes.

1. Press  then  until the display shows *X. Y. OZ.* "X" is the currently selected drink size for the regular drink, and "Y" is the currently selected drink size for the large drink.
4. Press  until the desired regular drink size is displayed; press  until the desired large drink size is displayed.

5. Any changes made to the cup sizes must be "locked in". There are two ways to do this:
 - a. If you are keeping some cup sizes the same, or putting the same cups in different cup rings, press and hold . The display momentarily shows *CLEARING*, two beeps sound, then shows *FINISHED*. This will reassign the old throw times to the new cup size, if possible.
 - b. If you are loading all different size cups, or want to load all new default times, press and hold . The display momentarily shows *CLEARRING*, two beeps sound, then shows *FINISHED*. This will reload the factory default times for all cup sizes, clearing any custom throw times you have established. (See the tables on the following pages for the factory default times.)
2. CONTINUE.

EUROTWIN OPERATOR'S GUIDE



SET UP A HOT DRINK

Be sure that the cup sizes you set in **SET UP CUP SIZES** agree with the cup sizes actually in your machine. All procedures for setting up the hot drinks are similar, so this example will demonstrate how to set up the A selection, regular size fresh brew coffee.

1. Press then until the display shows **SETUP - ***. The star (*) represents the selection (A, B, etc.). The dash (-) represents the size of the selection.
 1. Press **A**. (If you were setting up the A selection for the large size drink, you would press 1 first, then A.) The display shows **WAT. A 8.25**. This means that the currently set water throw time for the A selection is 8.25 seconds. Enter a new time if desired.
 2. Press . The display shows **DRY. A .60**. This means that the currently set dry product throw time for the A selection is .60 seconds. Enter a new time if desired.
 3. Pressing after each display will cause the following screens to appear:
 - DRY. A+** View and change the settings for an extra strong drink
 - SUG. A** View and change the settings for the sugar throw time
 - SUG. A+** View and change the settings for extra sugar throw time
 - LIT. A** View and change the settings for the lightener throw time
 - LIT. A+** View and change the settings for extra lightener throw time
 - SUB. A** View and change the settings for the sugar substitute throw time
 - SUB. A+** View and change the settings for extra sugar substitute throw time
 - STP. A** View and change the steep time
 - STP. A+** View and change the steep time for an extra strong drink
 - AIR. A** View and change the air compressor running time

WHP.AXXX

Press  to view and change the whipper settings as follows:

- ON-** The last 3 seconds of the drink is always whipped
- ON+** The whole drink is always whipped
- OFF** The drink is never whipped

• If **J +** is selected (see *VIEW MACHINE OPTIONS*):

- OPT-** The last 3 seconds of the drink is whipped only when the J key is pressed
- OPT+** The whole drink is whipped only when the J key is pressed

• If **J -** is selected (see *VIEW MACHINE OPTIONS*):

- OPT-** The last 3 seconds of the drink is whipped unless the J key is pressed
- OPT+** The whole drink is whipped unless the J key is pressed

DIFFERENCES:

Some selections will not show all of these items. For example, the **C** selection has only the water throw time displayed. The **E** selection will have some additional selections:

WR.2E View and set the water throw time for the cappuccino second product (chocolate)

DR.2E View and set the chocolate throw time for cappuccino

OPTIONS:

- a. At any of the preceding displays, you can press  to test throw that item.
- b. At any of the preceding displays, you can press * or # (on the selection switch panel) to step through a list of that item's throw times for other selections where that item is active. For example, pressing # at the **WRT.A** display will show the throw time for **WRT.B**. This is a handy way to move from one selection to another without going to the **SETUP** screen first.

NOTE

If you try to set up a selection that is not configured, the **SETUP** screen will remain in the display.

2. CONTINUE.



COLLECTING DRY PRODUCT GRAM THROWS

Measuring the gram throw allows you to get the right amount of dry product or condiment into your hot drink. To do this, you need a container to catch the product throw and an accurate gram scale to measure its weight.

1. Make a measuring container by cutting down a paper cup until it fits under the canister spout as shown.
1. Weigh the measuring cup and zero the gram scale accordingly.
2. Make 5 test throws as instructed in the programming steps.
3. Weigh each test throw, then add all 5 weights together and divide by 5 to get an average weight.
4. If necessary, adjust the throw time and repeat steps 3 and 4 until you get the correct product or condiment weight.

Tables D1 and D2 show the factory default settings for the various dry products sold by the merchandiser. They are good starting points for you to use in setting up your machine. In the end, the amount of dry product or condiments you use in your drinks depends upon taste and manufacturers' recommendations. Recommended weights and times are for guidance only, and you do not have to adhere to them.

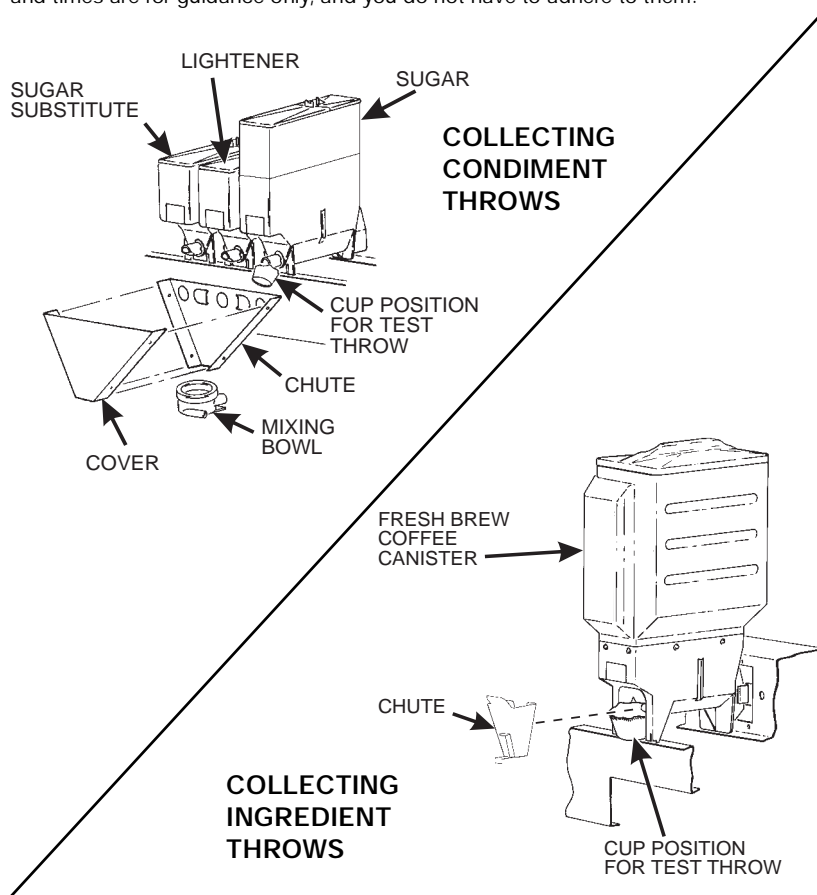

EUROTWIN OPERATOR'S GUIDE

Table D1. Dry Product Weight and Throw Time Factory Default Settings

Selection		Weight (in grams) per size cup					
		Throw times (in seconds) per size cup					
		5oz.	7oz.	8oz.	9oz.	10oz.	12oz.
A	Fresh brew coffee	5.70	8.00	9.00	10.00	11.00	13.00
		1.60	2.20	2.50	2.80	3.10	3.65
A	Freeze dry coffee	0.90	1.20	1.50	1.60	1.80	2.20
		0.35	0.50	0.60	0.65	0.70	0.90
A	Strong freeze dry coffee	1.10	1.50	1.80	2.00	2.20	2.60
		0.65	0.90	1.10	1.20	1.35	1.60
B	Fresh brew decaf	5.70	8.00	9.00	10.00	11.00	13.00
		1.60	2.20	2.50	2.80	3.10	3.65
B	Freeze dry decaf	0.90	1.20	1.50	1.60	1.80	2.20
		0.35	0.50	0.60	0.65	0.70	0.90
B	Strong freeze dry decaf	1.10	1.50	1.80	2.00	2.20	2.60
		0.65	0.90	1.10	1.20	1.35	1.60
D	Fresh brew coffee ESPRESSO	5.70	8.00	9.00	10.00	11.00	13.00
		1.60	2.20	2.50	2.80	3.10	3.65
D	Freeze dry coffee ESPRESSO	0.90	1.20	1.50	1.60	1.80	2.20
		0.35	0.50	0.60	0.65	0.70	0.90
D	Strong freeze dry coffee ESPRESSO	1.05	1.50	1.80	2.00	2.20	2.60
		0.65	0.90	1.10	1.20	1.35	1.60
E	Fresh brew coffee CAPPUCCINO	5.70	8.00	9.00	10.00	11.00	13.00
		1.60	2.20	2.50	2.80	3.10	3.65
E	Freeze dry coffee CAPPUCCINO	0.90	1.20	1.50	1.60	1.80	2.20
		0.35	0.50	0.60	0.65	0.70	0.90
E	Strong freeze dry coffee CAPPUCCINO	1.05	1.50	1.80	2.00	2.20	2.60
		0.65	0.90	1.10	1.20	1.35	1.60
F	Instant tea	0.90	1.20	1.50	1.60	1.80	2.20
		0.70	1.00	1.25	1.30	1.60	1.85
F	Strong instant tea	1.10	1.50	1.80	2.00	2.20	2.60
		0.90	1.25	1.60	1.75	1.85	2.10
G	Chocolate	17.00	24.00	28.00	31.00	34.00	41.00
		2.80	4.00	4.65	5.15	5.65	6.80
H	Soup	4.30	6.00	7.00	7.60	8.50	10.20
		0.70	1.00	1.15	1.25	1.35	1.65
H	Soluble Product	10.0	13.5	16.2	17.8	19.7	23.7
		2.45	3.35	4.00	4.35	4.85	5.80

EUROTWIN OPERATOR'S GUIDE

Table D1. Dry Product Weight and Throw Time Factory Default Settings (Cont.)

Selection	Weight (in grams) per size cup					
	Throw times (in seconds) per size cup					
	5oz.	7oz.	8oz.	9oz.	10oz.	12oz.
Chocolate used in cappuccino	3.10	4.50	5.00	5.80	6.20	7.60
	0.55	0.75	0.85	1.00	1.05	1.30
Sugar used in espresso	2.10	3.00	3.50	4.00	4.50	5.50
	0.35	0.45	0.55	0.60	0.65	0.80
Extra sugar used in espresso	3.00	4.35	4.80	5.35	6.25	7.20
	0.50	0.65	0.75	0.80	0.90	1.05
Sugar used in cappuccino	3.50	5.10	6.00	6.80	7.70	9.40
	0.45	0.65	0.75	0.85	0.95	1.20
Extra sugar used in cappuccino	4.60	6.80	7.70	8.50	9.40	11.00
	0.60	0.90	1.00	1.10	1.20	1.45
Sugar used in tea	4.20	6.00	7.00	8.00	9.00	11.00
	0.55	0.75	0.90	1.00	1.15	1.40
Extra sugar used in tea	1.50	2.00	2.50	3.00	3.50	4.50
	0.70	1.00	1.15	1.25	1.40	1.65
Lightener used in tea	1.20	1.50	2.00	2.50	3.00	4.00
	0.70	0.85	1.15	1.45	1.70	2.25
Extra lightener used in tea	1.50	2.00	2.50	3.00	3.50	4.50
	0.85	1.15	1.45	1.70	2.00	2.60
Sugar substitute used in tea	0.60	0.85	1.00	1.10	1.30	1.50
	0.75	1.05	1.25	1.35	1.60	1.90
Extra sugar substitute used in tea	0.80	1.10	1.30	1.40	1.60	1.90
	1.00	1.35	1.60	1.75	2.00	2.40
Sugar	4.20	6.00	7.00	8.00	9.00	11.00
	0.55	0.75	0.90	1.00	1.15	1.40
Extra sugar	5.50	8.00	9.00	10.00	11.00	13.00
	0.70	1.00	1.15	1.25	1.40	1.65
Lightener	1.20	1.50	2.00	2.50	3.00	4.00
	0.70	0.85	1.15	1.45	1.70	2.25
Extra lightener	1.50	2.00	2.50	3.00	3.50	4.50
	0.85	1.15	1.45	1.70	2.00	2.60
Sugar substitute	0.60	0.85	1.00	1.10	1.30	1.50
	0.75	1.05	1.25	1.35	1.60	1.90
Extra sugar substitute	0.80	1.10	1.30	1.40	1.60	1.90
	1.00	1.35	1.60	1.75	2.00	2.40

The actual gram weight of a product or condiment throw will vary depending upon the type of product or condiment used. The weights given are approximate based upon factory testing

Separate sugar, lightener, and sugar substitute timers are available for selections A/B/C, D, E, and F.



COLLECTING HOT WATER THROWS

National Vendors recommends the factory default times be used for hot water throws to ensure proper mixing. Table W1 gives the factory default water throw times for the various size cups and product selections.



For a non-brewed selection, collect the water throws as follows:

1. Place a cup in the cup delivery station.
1. Ensure the merchandiser is using the factory defaults for the cup sizes (see **SET UP CUP SIZES**).
2. Initiate the water throw for a selection.
3. Remove the cup and pour the water into a graduated cylinder.
4. Refer to table W1 for the correct volume of water.
5. Adjust the **THROW TIME** for that selection and repeat steps 2 through 4 until the correct volume of water is thrown.
6. If you are unable to get the desired amount of water, reset the throw time to the factory default, then adjust the water valves. You may then readjust the throw times to fine-tune your water throws.

For a brewed selection, collect the water throws as follows:

1. Remove water supply hose from the brewer as shown on the next page.
7. Place the end of the hose in a graduated cylinder.
8. Follow steps 2 through 6 given for the non-brewed selection.
9. Replace the water supply hose on the brewer.

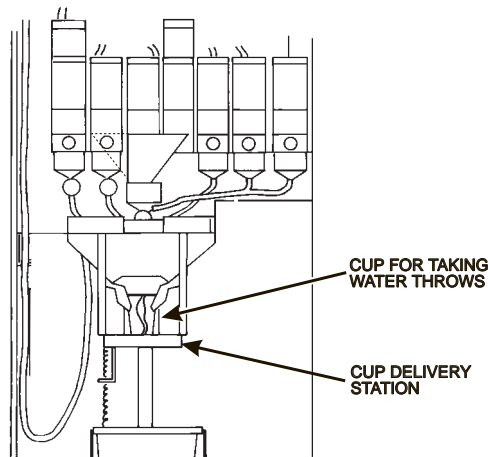

EUROTWIN OPERATOR'S GUIDE



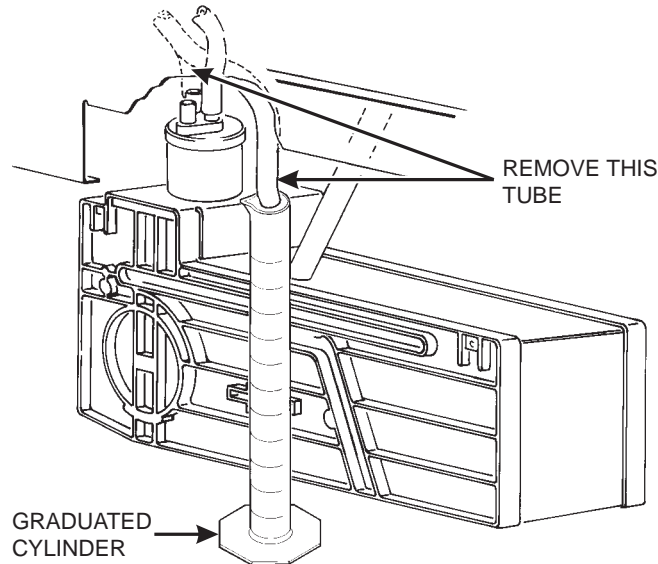

Table W1. Water Throw Default Times and Volumes

Selection		Time (in seconds) per size cup					
		Volume (in ml) per size cup					
		5oz.	7oz.	8oz.	9oz.	10oz.	12oz.
A	Fresh brew coffee	2.15 130	3.00 190	3.45 220	3.80 240	4.10 265	4.90 315
A	Freeze dry coffee	4.95 120	7.00 170	8.25 200	8.65 210	9.90 240	12.60 305
B	Fresh brew decaf	2.15 130	3.00 190	3.45 220	3.80 240	4.10 265	4.90 315
B	Freeze dry decaf	4.95 120	7.00 170	8.25 200	8.65 210	9.90 240	12.60 305
D	Espresso (FB)	2.25 65	3.20 95	3.75 110	4.10 120	4.50 133	5.50 158
D	Espresso (FD)	2.50 60	3.50 85	4.15 100	4.35 105	4.95 120	6.30 153
F	Tea	4.95 120	7.00 170	8.25 200	8.65 210	9.90 240	12.60 305
G	Chocolate	4.85 100	6.80 140	8.25 170	8.75 180	9.70 200	11.65 240
H	Soup or plain water	4.80 110	6.95 160	8.25 190	8.70 200	10.00 230	12.15 280
H	Soluble Product	4.85 100	6.80 140	8.25 170	8.75 180	9.70 200	11.65 240



 **SET UP A COLD DRINK**

Be sure that the cup sizes you set in **SET UP CUP SIZES** agree with the cup sizes actually in your machine. All procedures for setting up the cold drinks are similar, so this example will demonstrate how to set up the 5 selection.

1. Press  then  until the display shows *SETUP - **.
1. Press **1** and **5**. (For the "6" selection you would press 1 and 6, and so on.) The display shows *CLD. 15 6.80*. This means that the currently set non-carbonated cold water throw time for this selection is 6.80 seconds. Enter a new time if desired.
2. Press . The display shows *CRB. 15 6.80*. This means that the currently set carbonated cold water throw time for this selection is 6.80 seconds. Enter a new time if desired.
3. Pressing  after each display will cause the following screens to appear:

<i>SRP. 15</i>	View and change the syrup throw time
<i>PCT. 15</i>	View and change the settings for the percentage of carbonation (0- 100)
4. At any of the preceding displays, you can press  to test throw that item.
2. CONTINUE.

NOTE

The typical cold drink setup allows both a carbonated and still (non-carb) version. There may be cases when you wish to serve only one or the other.

To set up a still (non-carb) only, set the carbonation percentage (*PCT. 15. XX*) to zero (*PCT. 15. 00*). This setup will cause both versions to vend with no carbonation.

To set up a carb only drink, set the desired carbonation level on the

percent screen, then press . The display shows an asterisk

to indicate this selection is carb only (*PCT. 15 *XX*). Press

 again to remove the asterisk and allow still drinks.

EUROTWIN OPERATOR'S GUIDE



COLLECTING COLD WATER AND SYRUP THROWS



1. Place a cup in the cup delivery station.
1. Ensure the merchandiser is using the factory defaults for the cup sizes (refer to **SET UP CUP SIZES**, page 36).
2. Initiate the water (or syrup) throw for a selection.
3. Remove the cup and pour the liquid into a graduated cylinder.
4. Compare the measured throw to the volume as shown in table W2.
5. Adjust throw times to get the desired volume.
6. If you are unable to get the right volume by adjusting the throw times, reset throw times to the factory default, then adjust the water (or syrup) valve for that selection (see **ADJUSTMENTS AND MINOR MAINTENANCE**, page 11). Repeat steps 2 through 6 until the correct volume is thrown.

Table W2. Cold Water and Syrup Throw Default Times and Volumes

CUP SIZE		SYRUP			PLAIN WATER			CARB. WATER		
		VOLUME		TIME (SEC)	VOLUME		TIME (SEC)	VOLUME		TIME (SEC)
ML.	OZ.	ML.	OZ.		ML.	OZ.		ML.	OZ.	
177	6	25	0.85	2.5	125	4.2	4.25	125	4.2	4.25
207	7	30	1	3	150	5	5.25	150	5	5.25
244	8.25	36	1.2	3.5	181	6.1	6	181	6.1	6
266	9	40	1.4	4	200	6.7	7	200	6.7	7
296	10	45	1.5	4.25	222	7.5	8	222	7.5	8
355	12	50	1.7	4.5	250	8.5	9	250	8.5	9





VIEW SOFTWARE VERSION

1. Press , and press  until the display shows *VER XXXXXX*.
"XXXXXX" represents the current software version number.
2. CONTINUE.





SET HOT AND COLD TEMPERATURE

1. Press  then  until the display shows **35 °F 202** . In this example, 35 is the cold plate temperature setpoint and 202 is the water tank temperature setpoint in degrees Fahrenheit. If a decimal point appears next to the tank temperature number, the heater is on. If a decimal point appears next to the cold plate temperature number, the compressor is on.
1. If desired, enter a new setpoint in the accepted range of 149° - 205° F (65° - 96° C).

NOTE

The lower limit for vending is 10× below setpoint, up to a maximum of 180× F (82× C).

2. To change display units (replace the "F" with a "C" for Celsius), press  .
3. The cold plate temperature can be adjusted between 34° and 49° F (1° - 9° C).
Press  to increment to the next degree. Continue pressing to roll over back to 34° F.

CAUTION



Setting the cold plate temperature too low may result in freezing the plate. Be careful when adjusting the cold temperature.

2. CONTINUE.



SET THE AUTOMATIC BREWER RINSE TIME (BREWER EQUIPPED MACHINES ONLY)

The brewer will be automatically rinsed by one of two methods: You can specify a set time of day when the brewer is rinsed, or you can specify that rinsing takes place a set time after the last brewed selection is vended.

1. Press  then  until the display shows one of the following:

SAN.TIM 4.5 The time of day (in hours and tenths of hours) the machine rinses the brewer. In this example, brewer rinse takes place each day at 4:30 am. Range: 0.0 - 23.9 in .1 hour (6 minute) increments.

OR

SAN.HRS 2.5. In this example, brewer rinse takes place 2.5 hours after the last vend. Range: 2.0 - 12.5 hours, in .1 hour (6 minute) increments.

NOTE



If 24 hours passes without a vend, no rinsing will take place. This eliminates unnecessary rinsing over a weekend or holiday.

1. Whichever one of the two choices is displayed is the method by which the brewer will be rinsed. Press  to switch between these two displays. Enter a new time, if desired.
2. CONTINUE.



SET THE AUTOMATIC MIXING BOWL RINSE TIME

Mixing bowl(s) can be automatically rinsed by one of two methods: You can specify a set time of day when the bowl is rinsed, or you can specify that rinsing takes place a set time after the last selection is vended.

1. Press  then  until the display shows one of the following:

RIN.HRS 2.5 - This is how soon the machine rinses the bowls after a vend. In this example, bowl rinse takes place 2.5 hours after the last vend. Range: 2.0 - 12.5 hours, in .1 hour (6 minute) increments.

OR

RIN.TIM 4.5 - The time of day (in hours and tenths of hours) the machine rinses the bowls. In this example, bowl rinse takes place at 4:30 am. Range: 0.0 - 23.9 in .1 hour (6 minute) increments.

NOTE

If 24 hours passes without a vend, no rinsing will take place. This eliminates unnecessary rinsing over a weekend or holiday.

OR

RINSE OFF - No bowl rinse takes place.

1. Press  to switch between these options, and the number keys to enter new values.
2. CONTINUE.

EUROTWIN OPERATOR'S GUIDE



SET THE TIME OF DAY

1. Press . The display shows *TIME HH.MM*. "HH.MM" is the time of day in 24-hour format.
1. Enter the current time using the number keys.



NOTE

9:00 am is entered with a leading zero, like this: 0900; 9:00 pm is entered as 2100.

2. CONTINUE.
-





SET THE DAY OF THE WEEK

1. Press , and press  until the display shows @ *SMTWTF5*. The letter representing the currently set day of the week will be flashing.
 2. Press  until the correct day of the week is flashing.
 2. CONTINUE.
-





SET MONTH, DAY, AND YEAR

1. Press , and press  until the display shows *MM/DD YY*. "MM" is the month, "DD" is the date, YY is the year.
3. Enter the current month, date, and year using the number keys.
For example, press the following keys to enter February 22, 1996:
0, 2, 2, 2, 9, 6
4. Press  to switch between MM/DD and DD/MM formats



SET TIME-OF-DAY INHIBITED VENDING



Vending can be inhibited up to four times a day.

1. Press , then press  until the display shows *INHIB* ----.
 2. Go to the **TIME INTERVAL EDITING** procedure, page 52 for an example of how to set up time-of-day inhibited vending.
-



SET TIME-OF-DAY FREE VENDING



Vending can be free up to four times a day.

1. Press , then press  until the display shows *FREEV* ----.
 2. Go to the **TIME INTERVAL EDITING** procedure, page 52 for an example of how to set up time-of-day inhibited vending.
-



SET TIME-OF-DAY DISCOUNT VENDING

Vending can be discounted up to four times a day. For example, this can be used to favor early-arriving employees..

1. Press , then press  until the display shows *DISCT* ----.
2. CONTINUE. Go to the **TIME INTERVAL EDITING** procedure, page 52 for an example of how to set up time-of-day inhibited vending.



TIME INTERVAL EDITING

You can select up to four times of day for each special vending period.





NOTE



If two or more of these time periods overlap, the interval with the highest priority will overrule the other(s). This order of precedence is:

1. INHIBIT
3. FREEVEND
4. DISCOUNT





For example, if a DISCOUNT time period is scheduled for a certain area before the end of an INHIBIT time period, DISCOUNT does not begin until the INHIBIT interval has ended for that area.

The time interval editing procedure is almost the same for the INHIBIT, FREEVEND, and DISCOUNT intervals. There is one difference for the DISCOUNT time interval, so we will use it in our example. Assume you just finished the SET TIME-OF-DAY DISCOUNT VENDING procedure. Step 1 picks up where you left off . . .

1. The display shows *DISCT----*. Press the number of the time interval you want to edit, or  to edit time interval 1 (we'll use interval 1 for this example).
5. The display shows *1.DISCT ON* or *1.DISCT OFF*. This display tells you whether your time interval (represented by 1) is on or off. Press  to change the condition of the time interval.
6. Press . The display shows *1.DSCT X*. "X" represents the discount percentage for this period. Enter a discount percentage of 25 with the number keys. (Discount percentages of from 0 to 99 are permitted.) The machine will apply a 25% discount to each price, rounding up to the nearest nickel (or whatever is the smallest coin accepted by the coin mechanism).
7. Press . The display shows *1.STRT X.XX*. "X.XX" is the currently set start time. Enter a new start time (24-hour format) for this interval. To enter the time for 3:30 pm, enter 1530.

8. Press  . The display shows *1.STOP X.XX*. "X.XX" is the currently set stop time. Enter a new stop time (24-hour format) for this interval. To enter the time for 6:00 pm, enter 1800. You have now established a 25% discount that starts at 3:30 pm and ends at 6:00 pm.
9. Press  . The display shows *1.@ - - - - -* . The dashes represent the days that this time interval is active. Pressing number keys 1 through 7 switches the days on/off. For example, press "2", "4", and "6". The display now shows *1.@ -M-W-F-* . This discount interval is only active on Monday, Wednesday, and Friday.
10. Press  . The display shows ** - - - - -* . The dashes represent the selections affected by this time interval. Press the appropriate letter key to enable a selection, press the key again to disable it. For example, pressing A, C, and E will cause the display to look like this: *A-C-E - - -* , meaning that all A, C, and E selections are affected by this interval.



Advanced Options:

- Press  to turn on all levels; press  to turn all levels off.
 - Press **0** or **1** to enable selections by cup size.
11. Press  . The display shows *1.MESG OFF* or *1.MESG X*. "OFF" means there is no custom message selected, and "X" represents the custom message number set for this interval. Press the number key of the message (1 through 8) you want displayed. To edit this message, press  and follow the procedure given in **EDIT CUSTOM MESSAGES**, page 56. Press 0 to turn the message OFF for this time interval.
2. CONTINUE.

STANDBY MESSAGE The message that is displayed during normal vending periods when there are no out-of-service faults on the machine.





SELECT A STANDBY MESSAGE

1. Press , then press  until the display shows **STANDBYXX**. "XX" represents the current message number selected for the standby message. Two dashes mean that the factory-set message is selected.
 12. To select a message, just press the corresponding number (1 through 8). To display the factory-set message, press 0.
 13. The selected message (except the factory-set message) can be edited. To do this, press  and follow the procedure given in **EDIT CUSTOM MESSAGES**, page 56.
2. CONTINUE.
-



SELECT AN OUT-OF-SERVICE MESSAGE

1. Press , then press  until the display shows **SERVICEXX**. "XX" represents the current message number selected to display when the machine is out-of-service. Two dashes mean that the factory-set message is selected.
 14. To select a message, just press the corresponding number (1 through 8). To display the factory-set message, press 0.
 15. The selected message (except the factory-set message) can be edited. To do this, press  and follow the procedure given in **EDIT CUSTOM MESSAGES**, page 56.
2. CONTINUE.



SELECT A FREEVEND MESSAGE

1. Press , then press  until the display shows *FREEVEND XX*.

"XX" represents the current message number selected for the message that displays when the machine is in the freevend mode. Two dashes mean that the factory-set message is selected.







1. To select a message, just press the corresponding number (1 through 8). To display the factory-set message, press 0.
2. The selected message (except the factory-set message) can be edited. To do

this, press  and follow the procedure given in **EDIT CUSTOM MESSAGES**, page 56.

2. CONTINUE.





EDIT CUSTOM MESSAGES

1. Press , and press  until the display shows *EDIT MSG'S*. Press the number of the message you want to edit. *MESSAGE X* is displayed (X represents the message number you pressed).
1. Press . The message text is displayed with the first character flashing.
2. To view the message, press . The message scrolls across the display.
To stop the scrolling, press .
3. When the character you want to change is flashing, either enter it directly, or use  and  to step through the character set until the desired character is displayed. Use the arrow keys to highlight different characters. See the section on the next page for an explanation of special keys and the character set.

SHORTCUT

Instead of stepping through the whole character set to enter a letter that is not on your keypad, enter one close to the one you want, then step to it. Example: If you want to enter an L, first press

 to get an R, then press  six times. Your L should now be displayed.













THE END OF MESSAGE CHARACTER

This is the most important character in your message, because it tells the machine when the message is ended. If you don't use this character, your message will be followed by a bunch of nonsense. This character can be selected either from the character set or by a direct key entry (see the next page).



ENTERING YOUR MESSAGE

Most of the keys on the control panel have a special purpose to help you create and edit your messages:

- | | | | |
|---|---|---|--|
|  | Inserts an R at the flashing character. |  | Inserts a space at the flashing character. |
|  | Inserts an S at the flashing character. |  | Deletes the current character and closes up the space. |
|  | Inserts a T at the flashing character. |  | Deletes the current character and leaves the space. |
|  | Repeats the letter to the left of the flashing character. |  | Enters the special "end of message" character, which denotes the end of the message. |
|  | "Pages" through the message, ten characters (one screen) at a time. | | |
|  |  | Steps forward and backward through the message, one character at a time. | |
|  |  | Steps forward and backward through the character list, one character at a time. | |

THE CHARACTER SET

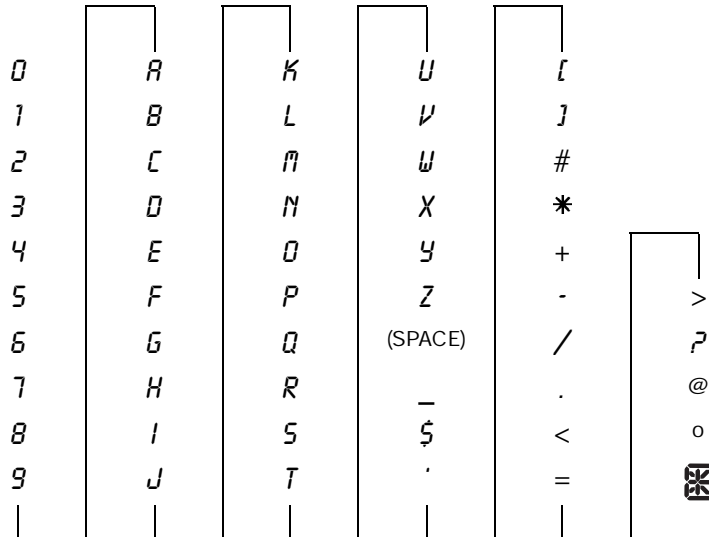









VIEW WATER TANK AND COLD PLATE TEMPERATURE

1. Press  . The display shows *XXX °F YYY*. "XXX" is the current cold plate temperature, "YYY" is the current water tank temperature. "°F" means that both temperatures are displayed in degrees Fahrenheit (may be shown in degrees Celsius, depending upon your choice. See **SET HOT AND COLD TEMPERATURE**, page 47). A decimal point shown in the display indicates that the tank heater or compressor is operating.
 2. CONTINUE.
-



VIEW MACHINE CONFIGURATION SETTING

1. Press  , then press  until the display shows *0-J-WXYZ*. See **SET UP MACHINE CONFIGURATION OPTIONS**, page 34, for an explanation of this display.
1. Press  . The display shows *0. ABCDEFG-*. This shows the active selections for the regular size drink (0).
2. Press  . The display shows *0. --56-89*. This shows the active cold drink selections for the regular size cup (0).
3. Press  . The display shows *1. ABCDEFG-*. This shows the active selections for the large size drink (1).
4. Press  . The display shows *1. --56-89*. This shows the active cold drink selections for the large size cup (1).
2. CONTINUE.



PAYOUT COINS

1. Press . If a dumb mech was selected, the display shows *NDQ = 123*; if an MDB mech was selected the display shows *PAY 123*.
1. Press . A dumb mech pays out one *N*ickel; an MDB mech pays a coin from tube 1. Press . A dumb mech pays out one *D*ime; an MDB mech pays a coin from tube 2. Press . A dumb mech pays out one *Q*uarter; an MDB mech pays a coin from tube 3.
2. To continuously pay out coins, hold down the appropriate key.
2. CONTINUE.

EUROTWIN OPERATOR'S GUIDE



SET PRICES

1. Press . The display shows **** 2.50 .25**. This display shows the maximum and minimum prices set in the machine. In this example, the maximum price is \$2.50 and the minimum is \$0.25.

1. Enter prices as using one of the following methods:

SET ENTIRE MACHINE TO ONE PRICE . . .

- a. Press . The display shows **** X.XX**. Enter a price using the number keys. All selections in the machine are now set to this price.

SET THE PRICE OF AN INDIVIDUAL SELECTION . . .

- a. Press the number of the selection to be priced. (Example: 1A.) The display shows **1A X.XX**. Enter a price using the number keys. The selection is now priced.

- b. Press another letter key, or  to price another selection.

SET ALL CUP SIZES TO ONE PRICE . . .

You can set all regular drinks to one price, and all large drinks to a different price:



- a. Press 0 for regular size, or 1 for large size cups. If you pressed 1, the display shows **1* .XX .XX**. This is the currently set minimum and maximum price.

- b. Press . The display shows **1***.

- c. Enter a price using the number keys. All large cup drinks are set to one price.

- d. Press  to change the other size cup.



SET ALL SIZES OF A SELECTION TO ONE PRICE . . .

- a. Press a selection letter (**A - H, X, Y, Z, 8, or 9**). If you pressed **C**, the display shows ***C .XX .XX**. This is the currently set maximum and minimum price.
- b. Press . The display shows ***C**. Enter a price using the number keys. All sizes of this selection are set to one price.
- c. Press  or another selection letter to change other selections.

2. CONTINUE.



VIEW NONRESETTABLE SALES AND VEND DATA

1. Press . The display shows **NR\$ XX.XX**. "XX.XX" is a dollar and cents figure showing the total of all sales in the machine. This is a running total, and is not resettable.
1. Press . The display shows **NR X**. "X" is the total number of vends made by the machine. This is a running total, and is not resettable.
2. CONTINUE.



EUROTWIN OPERATOR'S GUIDE



VIEW DATA THREE DIFFERENT WAYS

Paid sales and vends can be viewed three different ways: By whole machine, by selection, and by drink size within the selection. The first screen of the data item shows its machine total.

- To view the data by selection, press the letter of the selection you want to see.

You can then press  and  to see data for all the active selections.

- To view the data by drink size:
 - Press **0** for regular size drinks or **1** for large size drinks.
 - Press the letter of the selection you want to see.

FOR EXAMPLE: To view the data for a large A selection, press 1A. The data will be displayed.

You can then press  and  to see data for all the active selections of that size.



VIEW TOTAL PAID SALES



- Press , then press  until the display shows ****\$ XX.XX**.

"XX.XX" is a dollar and cents figure showing the total of all PAID sales in the machine (as opposed to unpaid sales like winner and free vends). This is the total since the last time it was cleared.

- If desired, view this data by individual selection or drink size.
- CONTINUE.





VIEW TOTAL PAID VENDS

- Press , then press  until the display shows **** XX**. "XX" is the total number of paid vends for the entire machine.

- If desired, view this data by individual selection or drink size.
- CONTINUE.





CLEAR ALL RESETTABLE DATA

1. Press . The display shows *NR\$ XX.XX*. This is a running total, and is not resettable.
 1. Press and hold . Two beeps sound and the display shows *CLEARING* momentarily, and then changes to *FINISHED*. All data is cleared.
 2. CONTINUE.
-





CLEAR PAID SALES DATA ONLY

1. Press  , then press  until the display shows ***\$ XX.XX*.
"XX.XX" is a dollar and cents figure showing the total of all **PAID** sales in the machine (as opposed to unpaid sales like winner and free vends). This is the total since the last time it was cleared.
 2. Press and hold . Two beeps sound and the display shows *CLEARING* momentarily, and then changes to *FINISHED*. All paid sales data is cleared; other data is not cleared.
 2. CONTINUE.
-







VIEW AMOUNT IN COIN BOX (NOT SHOWN IF ZERO)

1. Press  , then press  until the display shows *CBX XX.XX*.
"XX.XX" is the dollar and cents amount in the coin box.
2. CONTINUE.

EUROTWIN OPERATOR'S GUIDE







VIEW AMOUNT IN VALIDATOR (NOT SHOWN IF ZERO)

1. Press , then press  until the display shows *DBV XX.XX*.
"XX.XX" is the dollar amount in the bill stacker.
 1. Press  to show the quantities of bills in the stacker. For example, the display shows *\$01 20*, meaning that there are 20 dollar bills in the bill stacker.
Press  again to show the quantities of other bills, such as \$5s, \$10s, or \$20s.
 2. CONTINUE.
-







VIEW FREEVEND SALES BY TIME INTERVAL (NOT SHOWN IF ZERO)

1. Press , then press  until the display shows *-0\$ XX.XX*.
 2. Press , then press  until the display shows *1.FRV .00*. This is the total sales for freevend interval 1, shown even if zero.
 3. Press  to view intervals 2 through 4.
 2. CONTINUE.
-



VIEW DISCOUNT SALES BY TIME INTERVAL

1. Press , then press  until the display shows ***\$ XX.XX*.
 4. Press . The display shows *1.DSC .00*. This is the total sales for discount interval 1 (not shown if zero).
 5. Press  to view intervals 2 through 4.
 2. CONTINUE.
-



VIEW FREE VENDS (NOT SHOWN IF ZERO)

1. Press , then press  until the display shows *-0\$ XX.XX*.

1. Press , then press  until the display shows *FRV XX.XX*.

"XX.XX" is the total machine-wide freevends, shown even if zero.

2. CONTINUE.



VIEW WINNERS (NOT SHOWN IF ZERO)

1. Press , then press  until the display shows *-0\$ XX.XX*.

2. Press , then press  until the display shows *WIN XX.XX*.

"XX.XX" is the total machine-wide winners, shown even if zero.

2. CONTINUE.

EUROTWIN OPERATOR'S GUIDE



VIEW TIME DATA

1. Press , then press  until the display shows *TIME DATA*.

1. Press . The following message scrolls across the display:

LAST POWER 01/30 13.51 FOR 00. 0.23

This example shows that the last time the machine lost power was on January 30 (01/30) at 1:51pm (13.51) for zero days, zero hours, and 23 minutes (00. 0.23).

2. Press . The following message scrolls across the display:

LONGS.T POWER 01/30 10.58 FOR 00. 2.47

This example shows that the longest time the machine was without power was on December 30 (01/30) at 10:58am (10.58) for zero days, 2 hours and 47 minutes (00. 2.47).

3. Press . The following message scrolls across the display:

FULL CLEAR 01/30 8.58

This example shows that the last time resettable sales was fully cleared was on January 30 (01/30) at 8:58am (8.58).

4. Press . The following message scrolls across the display:

TIME SET 01/30 9.15

This example shows that the last time the time or date was set was on December 30 (01/30) at 9:15 am (9.15).

5. Press . The following message scrolls across the display:

PRICE SET 01/30 9.42

This example shows that the last time prices were set was on December 30 (01/30) at 9:42 am (9.42).



2. CONTINUE.



VIEW TOTAL UNPAID SALES



NOTE

This does not appear if the total of unpaid sales is zero.

1. Press , then press  until the display shows **_0\$ XX.XX**.
"XX.XX" is the total unpaid sales (free vends, winner vends, 100% discounts, zero price vends) for the entire machine.
 1. If desired, view this data by tray and individual selection.
 2. CONTINUE.
-





VIEW TOTAL UNPAID VENDS

1. Press , then press  until the display shows **_0 XX**. "XX" is the total number of unpaid vends for the entire machine.
 2. If desired, view this data by tray and individual selection.
 2. CONTINUE.
-





VIEW NUMBER OF TEST VENDS (NOT SHOWN IF ZERO)

1. Press , then press  until the display shows **TST X**. "X" is the number of test vends.
 3. If desired, view this data by tray and individual selection.
 2. CONTINUE.
-





VIEW NUMBER OF MUG VENDS (NOT SHOWN IF ZERO)

1. Press , then press  until the display shows **MUG X**. "X" is the number of mug vends.
 4. If desired, view this data by tray and individual selection.
 2. CONTINUE.
-

EUROTWIN OPERATOR'S GUIDE



VIEW MACHINE ID NUMBER

1. Press , then press  or  until the display shows *I.D.*
XXXXXX. The X's represent the 6-digit machine ID number.
 1. You can edit the machine ID number if the SUPERVISOR access code has been previously entered.
 2. CONTINUE.
-



TEST VEND SELECTIONS AND VERIFY CREDIT ADDED

1. Press . The display shows *TEST .00*. You may now test vend selections. If you insert money into the machine, the zeros in the display will be replaced with the amount of the credit. After the item vends, your money will be returned.





NOTE

You may make one more test vend if you close the door while still in TEST VEND mode.



2. CONTINUE.
-





TEST THE DISPLAY

1. Press , then press  until the display shows *DSPLY TEST*. The "DRINK BEING SERVED" lamp is lighted, and remains lighted until you leave this function.
 2. Press  to light all display segments; press  to turn them off.
 3. Pressing a **NUMBER KEY** on the control panel causes all segments to display that character.
 2. CONTINUE.
-



 **TEST DROP A CUP**

1. Press , then press  until the display shows *CUP TEST*.
 1. Press  to drop a cup.
 2. CONTINUE.
-

 **TEST THE WHIPPER(S)**

1. Press , then press  until the display shows *WHIP TEST*.
 2. Press the number corresponding to the whipper you want to test (**1, 2, or 3**). The whipper runs for one second. Whipper numbers will be displayed while the whipper is running.
 2. CONTINUE.
-

 **TEST THE AIR COMPRESSOR**

1. Press , then press  until the display shows *AIR TEST*.
3. Press  to run the air compressor.
2. CONTINUE.

EUROTWIN OPERATOR'S GUIDE



TEST THE BREWER

1. Press , then press  until the display shows *BREW TEST*.

WARNING

Keep away from the brewer mechanism while it is operating. Coming into contact with moving parts could injure you.

1. Press  to test each brewer position:

BREW'R BREW = The brewer is in the BREW POSITION.



BREW'R FLIP = The brewer is in the FLIP position.

BREW'R HOME = The brewer is in the HOME position.

2. CONTINUE.
-





RINSE THE MIXING BOWLS



1. Press , then press  until the display shows *BOWL RINSE*.
 2. Press  to rinse the mixing bowls. The display shows *RINSING* until the operation is complete.
 2. CONTINUE.
-







RINSE THE BREWER

1. Press , then press  until the display shows *BREW RINSE*.
3. Press  to rinse the brewer. The display shows *RINSING* until the operation is complete.
2. CONTINUE.



 **PURGE THE CARBONATOR**

1. Press , then press  until the display shows *PURGE TEST*.
 1. Press  to purge the carbonator without refilling it.
 2. CONTINUE.
-

 **CLEAR TANK ERRORS AND FILL THE TANK**

1. Press , then  until the display shows *TANK FILL*.
 2. Press . This clears any tank error and starts filling the tank, if necessary.
If it is taking a long time to fill the tank **AND THERE ARE NO LEAKS**, you may see *TANKERR* in the diagnostic list again. Just press  again after making sure there are no other problems, such as a restriction in the water inlet line or a clogged water filter.
 2. CONTINUE.
-

 **TEST SWITCHES OR SENSORS**

1. Press , then  until the display shows *IN.MKPHL*.
 3. Actuate each switch or sensor to test its function:
M = mug/cup sensor (if equipped) K = freevend keyswitch
P = waste pail switch H = high water tank level switch
L = low water tank level switch 1 = ring 1 cup sensor switch
As you actuate each input, the display element representing that switch blinks on. Releasing the switch causes that element to blink off again.
 4. Press . The display shows *IN. CP*.
C = No CO₂ pressure
P = Carb tank low level.
 2. CONTINUE.
-



VIEW DIAGNOSTIC MESSAGES

1. Press  . the display shows any of the following diagnostic messages,

depending upon any fault(s) present:

NO ERRORS	None of the following errors are detected:
KEYPAD XY	Key(s) x, y stuck.
ROM ERROR	Error in the programming EPROM. MACHINE WILL NOT OPERATE.
RAM ERROR	RAM is not initialized or is not compatible with the currently loaded software. If this message appears, initialize your RAM by performing the following procedure:

NOTE: Initializing RAM will erase all your data and drink settings. Be sure you have written this information down before continuing.

Press **AND HOLD**  until two beeps are heard, and the display shows **FINISHED**.

KEYSWITCH	The keyswitch input is active and configured as an inhibit.
D + J + WXYZ	Configuration error; displays the machine configuration screen. NOTE: this is the actual config screen. You may enter the correct config number directly on this screen without further action.
TANKERR	Tank failed to fill or refill.
RING MTR	The cup ring is jammed.
MTR1A1B	Cup turrets are jammed
NO CUPS	Out of cups.
BREW JAM	The brewer is jammed.
WASTE PAIL	The waste pail is full.
LOW WATER	The water level in the tank is low.
COLD WATER	Water in the tank is too cold to vend.
WARM PLATE	The cold plate is warm.
OVERTEMP	Inlet water is too warm to operate compressor
SENSOR 1 2	Temp sensor failed or missing 1 = float sensor, 2 = coldplate.
WHIP 1 2 3	Whipper motor failure (motor 1, 2, or 3).
DOOR JAM	The automatic delivery door is jammed.
NO CO2	CO ₂ pressure is low.
SYRUP 1 2	Syrup tank(s) are low (tank 1, 2).

EUROTWIN OPERATOR'S GUIDE

NO MECH	Coin mech not detected - machine will not operate if configured for coin mech.
MECH COMM	Incomplete coin mech communications — check harness.
MECH.SENSOR	Coin mech reporting a bad tube sensor — replace mech.
MECH ROM	Replace the coin mechanism.
MECH.ACCEPT	Coin mechanism acceptor section is unplugged from the main body of the coin mech. Connect the cable and cycle machine power OFF and then ON.
MECH JAM	One or more coin tubes are jammed. Pay a coin from each tube until the jam is cleared.
DEBIT CARD	Card reader reporting error — machine will not operate if configured for DEBIT ONLY.
CHECK DBV	Bill validator reporting error — machine will not operate. Empty stacker, clear jams, etc.
DBV COMM	Incomplete bill validator communications — check harness.
DBV MOTOR	One of the motors has failed. The unit will disable itself until the error is corrected. Check for bill stuck in the acceptance path. If no bill is present, replace the validator. Cycle machine power OFF and then ON.
DBV SENSOR	One of the sensors in the bill validator has failed. The unit will disable itself until the error is corrected. Check for bill stuck in the acceptance path. If no bill is present, replace the validator. Cycle machine power OFF and then ON.
DBV JAM	A bill is jammed in the acceptance path. The unit will disable itself until the error is corrected. Remove bill stuck in the acceptance path. Cycle machine power OFF and then ON.
DBV STACKR	The stacker is open or removed. The unit will disable itself until the error is corrected. Install the stacker correctly.
CHK PRICE	Price error detected and changed to maximum - check prices.
NONE READY	all selections are reported out of service.

EUROTWIN OPERATOR'S GUIDE



DOWNLOAD DATA TO A PDCD

1. Connect your portable data collection device (PDCD) in accordance with its operating instructions.

1. Press . Data is downloaded into your PDCD.

NOTE

Depending upon the setting selected in set PRINTER OR DEX options, data may be cleared after the download is complete.

2. CONTINUE.
-



SET FREEVEND OPTIONS

1. Press  until one of the following is displayed:

FREE OFF - Normal vending mode. No items are on freevend. (A closure on the optional keyswitch input causes the machine to go out of service.)

- OR -

FREE ALL - All items are on freevend. The credit display shows

NO MONEY REQUIRED

(A closure on the optional keyswitch causes the machine to go out of service.)

- OR -

FREE W/KEY - All items are freevended while there is a closure on the optional keyswitch input. Normal cash sales are supported when the optional keyswitch input is open.

- OR -

FREE ONCE - A closure on the optional keyswitch input causes only the next item to be freevended. Coin mechanism errors are ignored. this state is designed for card or token systems where one item is vended per token. Normal cash sales are also supported.

2. Press  until the option you want is displayed.

NOTE

See Appendix D for more information on the freevend keyswitch.

2. CONTINUE.
-

CLEANING AND SANITATION

BASICS

INTRODUCTION

Anybody who services vending machines must use proper sanitizing procedures. Health regulations require that hands be clean when cups, commodities, and food-contact parts are handled or serviced.

In addition, Health Departments require regular cleaning and sanitizing procedures for food contact parts.

The information in this section will explain how to clean and/or sanitize the merchandiser on a regular basis. A clean and well maintained merchandiser will provide a better product and greater safety for your customers.

CLEANING AND SANITIZING -- WHAT'S THE DIFFERENCE?

CLEAN means "free of visible soil". In cup vending machine servicing cleaning is done to maintain product quality and to remove food soils, oils, and mineral stains that could affect product taste, aroma, and appearance.

SANITIZING means the reduction to safe levels of the number of disease-causing bacteria that remain on the surface **after** cleaning. Therefore, cleaning and sanitizing are done in separate steps, as prescribed by health regulations and good industry practice.

When you sanitize you create a healthy and hygienic condition. This leads to wholesome food, which in turn leads to satisfied customers.

SANITIZING IS NO SUBSTITUTE FOR GOOD CLEANING

HOW DO I SANITIZE?

You can sanitize by using either of these two methods:

Chemicals: The object to be sanitized is treated with a bactericidal compound.

Heat: Raise the temperature of the object to be sanitized high enough to kill bacteria. Water must be at least 77°C (170°F).

Hot brew water (if available) is an acceptable sanitizer. When food-contact surfaces are washed and/or rinsed, use the hot water available in the machine.

Be sure to turn the machine off before using water on the machine.

In either case, the object to be sanitized must be thoroughly clean and completely rinsed in order for the sanitizing process to work. Caked-on soils, not removed by cleaning for example, may shield bacteria from a sanitizing solution.

EUROTWIN OPERATOR'S GUIDE

NOTE

Hot brew water may cause damage to some parts of the cooling system and should not be used in any procedure unless specifically stated.

Where "Warm Water" is suggested the temperature is designated to be a maximum of 50°C (122°F).

A GOOD PLACE TO START -- YOUR SANITATION KIT

You need to be sure that each machine is clean, safe and functioning when you leave the location. In order to properly do this, you need to have a complete set of the right tools.

Here is a checklist of the items needed for a good sanitation kit:

Sanitation pail

- Tube and nozzle brushes for food contact surfaces
- Utility brush for dry spillage around canisters, etc.
- Disposable towels, wet-strength and lint-free

NOTE

Wiping with towels can recontaminate sanitized food-contact parts. Therefore, towels should not be used to dry food-contact surfaces. Instead, these parts should be air dried.

- Spray detergent, diluted to desired strength
- Urn cleaner packets for coffee stains and oils
- Odor control chemicals for pails
- Replacement parts (if the exchange method is used)
- Cabinet polish or window cleaner for the outside of the machine

Feel free to add some items to this list. For example, you may want to use a portable vacuum cleaner.

EUROTWIN OPERATOR'S GUIDE

OVERALL CLEANING

Inspect your merchandiser both inside and out. Be sure to check corners and all less visible parts of the merchandiser.

Clean where needed.

Allow the inside of the cabinet to dry thoroughly before you close the door.

PREVENTIVE MAINTENANCE CLEANING

Periodically, you should visually inspect your merchandiser's hot water tank for excessive lime and scale buildup. This buildup on the tank walls, water valves and heater element will vary dramatically, depending upon water quality. You should develop a cleaning and deliming schedule based on the apparent local water quality.

NOTE

To aid in removing scale from your merchandiser, National Vendors has a service kit available: part number 6400080. In addition, if your machine has the Everpure water inlet filter system option, a second kit: part number 6400086 is also available.

CLEANING PROCEDURES

Non Food-Contact Parts

Cup Delivery Compartment - Remove the cup delivery compartment from the merchandiser. Thoroughly wash the cup delivery compartment using a clean, damp, disposable paper wiper. Rinse with clean, hot, flowing water. Reinstall.

Cabinet Cup Delivery Door - Wash with a clean, damp, disposable paper wiper.

Waste Bucket - Empty, wash with a chlorinate detergent or equivalent chemical and rinse with hot water. Sprinkle detergent powder in the bottom of the waste bucket to help control odors. Be sure to replace the overflow switch float.

Grounds Pail - Empty, wash and rinse with hot water. Reline the grounds pail with a clean plastic bag.

Brewer Mechanism - Remove the brewer mechanism from its mounting and rinse with hot water.

Cooling System - Wipe the top cover, any visible tubes and sides with a clean, damp, disposable paper wiper.

Ingredient Rinse Tray - Remove product canisters. Wash and rinse with hot water.

Exhaust Fan Filter - Remove the filter from its housing. Wash with soap and water, rinse, wring dry and replace into housing.

Cabinet Door - Wipe the inside and out with a clean, damp, disposable paper wiper.

Condenser - Clean with a small stiff brush. Avoid poking between the fins with screwdrivers or sharp objects which may puncture the condenser, requiring repairs.

EUROTWIN OPERATOR'S GUIDE

SANITATION PROCEDURES

Food-Contact Parts

All food-contact parts must be cleaned and sanitized. Air dry, do not wipe dry.

Ingredient Canisters - Empty and clean and sanitize by washing the canisters, augers and spouts with hot water and allow to air dry before returning to cabinet.

Mixing Bowls - The inside of all mixing bowls may be rinsed by performing the "Bowl Rinse" operation as outlined in the Programming section of this manual.

If needed, remove the mixing bowls from the dry ingredient shelf. Clean and sanitize the mixing bowls by washing with hot water. Allow to air dry before reassembling.

Whipper Caps and Impellers - Remove caps and impellers from the whipper housings. Clean and sanitize the caps and impeller housing by washing with hot water and allow to air dry before reassembling.

Hot Beverage Discharge Nozzles - Disconnect all of the hot beverage dispensing tubes from the nozzles. Remove the nozzles from the mounting bracket. Remove the cap from each nozzle. Dip the tube cleaner brush in a sanitizing solution and thoroughly clean the nozzles and caps inside and out. Rinse the tube cleaner brush thoroughly with clean, hot water and brush the nozzles thoroughly between each rinse. Use a clean, damp, disposable paper wiper. Rinse with clean, hot water and dry thoroughly before reinstalling.

Cold Beverage Discharge Nozzles - Clean by removing the stainless steel dispense tubes from the holder by releasing the two thumb screws. Immerse the dispense tubes in warm water to remove any external deposits and brush clean. Clean inside the tubes with a small brush. Flush with warm water. Reinstall nozzles.

Syrup Tubes - First ensure that the waste bucket is in place. Lift the syrup dip tubes from the product container, and place them in a container of warm water and test throw until clear water comes out of the dispense nozzle.

Place the dip tubes into the container of sanitizing fluid. Perform test throws until the fluid pours from the dispense nozzle. Leave stand for the period recommended by the manufacturer of the sanitizing fluid (usually 10 to 15 minutes).

Place the syrup dip tubes in a 5 - litre container of clean, cold water and flush 1 litre through each syrup line using the test throw procedure.

Cold Water System - Ensure that the waste bucket is in place. Empty the carbonator by test throwing carbonated water until you hear sputtering at the dispense nozzle.

Remove the Everpure filter. Load an Everpure sterilizing (dummy) cartridge with 2 fluid ounces of Milton 2 fluid and fit the cartridge to the machine.

Test throw still (non-carbonated) water to clear any air locks. Release and allow the carbonator to fill with solution.

Test throw both carbonated water and still water once more to ensure that all of the tubes are full of the sanitizing fluid.

Switch power "OFF" and allow the machine to stand loaded with the sanitizing solution for 10 minutes. To flush out the sterilizing solution, remove the dummy cartridge and replace the Everpure filter. Switch power "ON". Vend 3 litres of still water from the machine then vend 3 litres of carbonated water.

Brewer, Brewer Basket and Brewer Funnel - The tubing and brewer may be cleaned and sanitized by performing the "Brew Rinse" operation as outlined in the programming section. The machine features an automatic brewer sanitizing feature also described in the programming section.

At times, it may become necessary to clean and sanitize the individual brewer parts. If this should occur, disconnect the tubes from the brewer manifold. Remove the brewer barrel and manifold assembly from its support. Remove the brewer basket and funnel assemblies. Wash all parts using a chlorinated detergent or equivalent chemical. Rinse thoroughly with hot water.

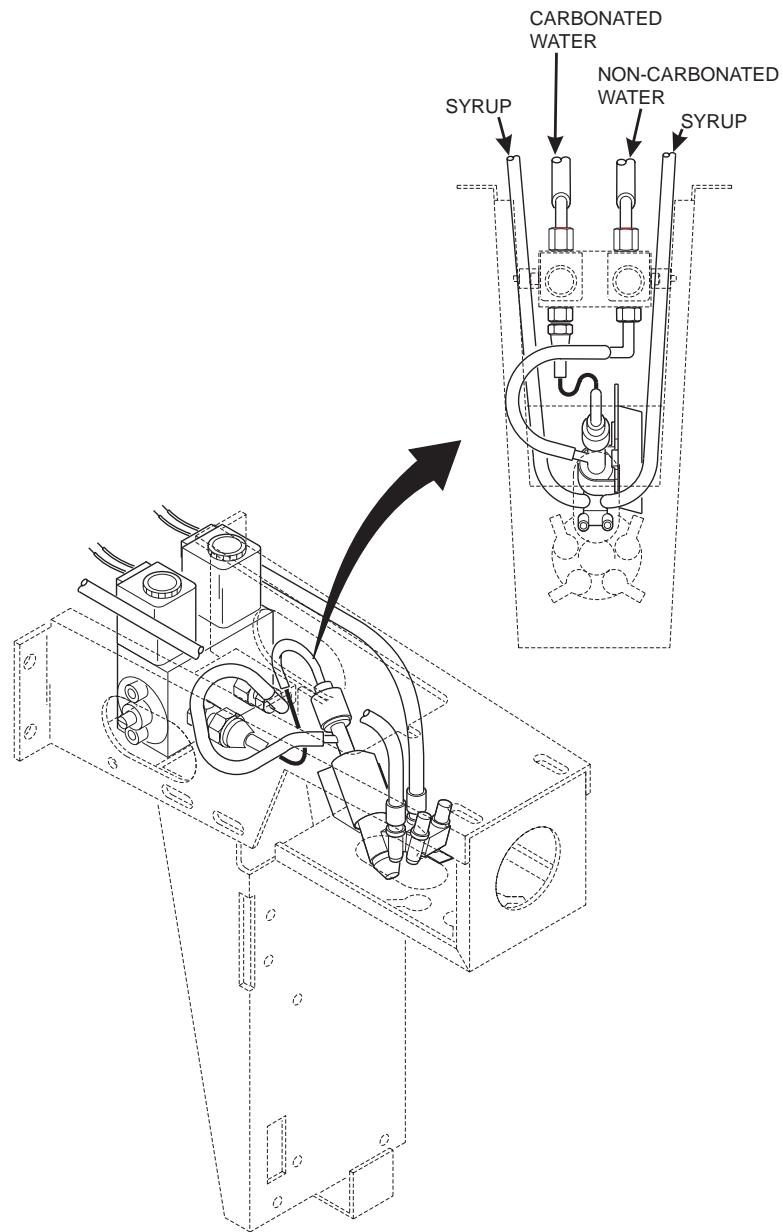

COLD DRINK TUBE ROUTING DIAGRAM

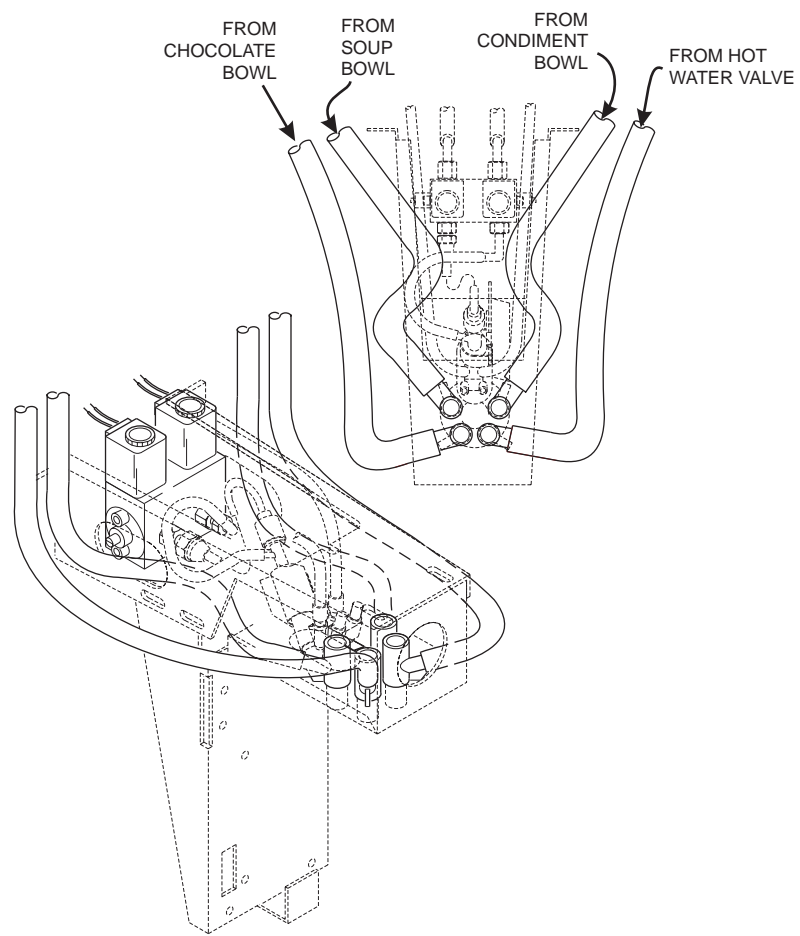

HOT DRINK TUBE ROUTING DIAGRAM

RECOMMENDED CLEANING AND SANITATION INTERVALS

ITEM	DAILY	WEEKLY	MONTHLY	QUARTERLY	SEMI-ANNUALLY
Ingredient Canisters	C		S		
Mixing Bowls	C	S			
Whipper Lids and Impellers	C	S			
Beverage Discharge Nozzles	C	S			
Cup Delivery Compartment	C				
Exhaust Fan Filter		C			
Waste Pail	C				
Brewer, Basket, Funnel	C	S			
Coffee Chutes	C	S			
Brewer Mechanism		C			
Grounds Pail	C				
S = Sanitize at this interval					
C = Clean at this interval					

APPENDIX A. THE INFRARED MUG/CUP SENSOR

The infrared mug/cup sensor can sense the presence of a mug or cup without using moving parts.

Indicator light

The sensor is equipped with an indicator light. This light will help you get the best results from the infrared mug/cup sensor.

Under these conditions:

- Machine door open
- Cup station in place
- No cup in the station

The indicator light should be off. If it is on, it is indicating improper cup station alignment or excessive sensor sensitivity.

Under these conditions:

- Machine door closed
- Cup station in place
- No cup in the station

Press any letter on the selection switch panel, for example, **A**. Only the letter **A** should be showing in the message display. If **AMUG** is displayed, it indicates one or more of the following:

- Improper cup station alignment
- Excessive sensitivity (the sensor is sensing the delivery door)
- Cup station lens is not clean

Cleaning

As indicated in the Sanitation section, you should remove the cup station to clean it. Pay particular attention to the dark colored infrared mug/cup sensor lens, which is part of the cup station. If it is not thoroughly cleaned, the sensor will not work properly.

CAUTION

Do not get liquid inside the sensor unit.

Cleaning the infrared mug/cup sensor unit itself is not usually necessary. If it does require cleaning, just wipe it with a damp cloth.

EUROTWIN OPERATOR'S GUIDE

Calibration

1. Remove the plastic cap in the rear of the sensing unit, exposing the potentiometer adjusting screw, as shown in figure A1.
3. Turn the screw clockwise to increase sensitivity of cup detection, or counterclockwise to decrease sensitivity.
4. Calibrate the sensor:

CAUTION

Do not adjust sensitivity too far, or unreliable sensing could result.

- a. Using a piece of **WHITE** poster board or heavy cardboard, make a 5" x 5-5/8" target.

NOTE

It is very important that this material be white.

- b. Place the target in the cup station just beyond the cup deflectors (see figure A-2). The target should be standing vertically; not tilted forward or backward.
 - c. With the target in place, turn the adjusting screw **clockwise** very slowly until the indicator just turns ON.
 - d. Turn the adjusting screw **counterclockwise** very slowly until the indicator just turns OFF.
1. Replace the plastic cap.
 2. Insert a mug into the cup station in the vending position and check to see that the red indicator light is ON.

This calibration will be adequate for most cups or mugs. In some cases, a slightly more sensitive setting is needed if the cup or mug is a dark color.

VIEWING REAR OF SENSOR ASSEMBLY

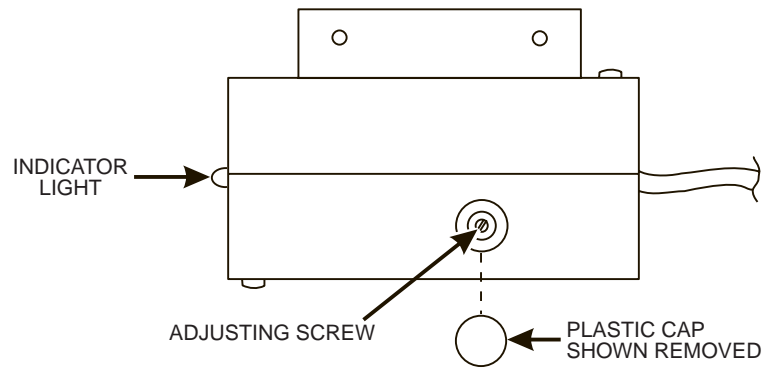

Figure A-1

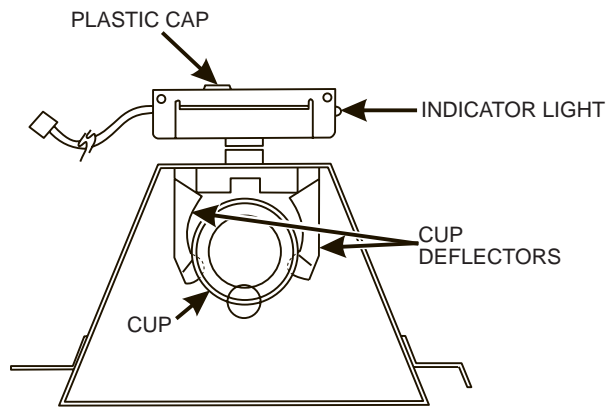

Figure A-2

THIS PAGE IS INTENTIONALLY LEFT BLANK

APPENDIX B. MODIFY CANISTER TO VEND 12 OZ. CUPS

Proceed as follows:

3. Remove all cups, then remove the turret center and turret base assembly from the canister.
4. Break off all 8 tabs on the bottom of the turret base as shown.

NOTE

You will no longer be able to vend smaller cups from this canister! To return to vending smaller cups you must replace the modified turret base with an original turret base (part number 6233048) from National Vendors Parts Department.

5. Replace the turret center and turret base in the canister and load cups.
6. Drop a cup. If it drops properly, you are finished with the procedure, if not, continue with step 7.
7. Remove all cups, then remove the canister from the cup mechanism assembly.
8. Remove the funnel, replace the canister, and reload cups.
9. Drop a cup. If it drops properly, you are finished with the procedure, if not, continue with step 10.
10. Order a 5 oz/18oz cup ring (part number 6233120) from National Vendors Parts Department.

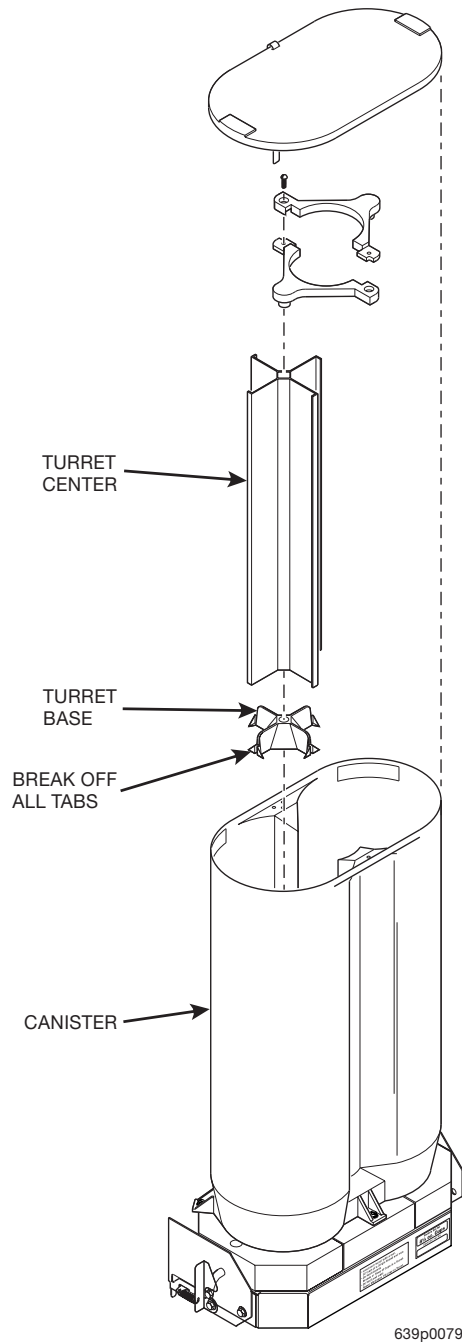

APPENDIX C. CLEAN THE HOT WATER TANK

Some smell and/or taste problems may occur in new machines. Follow this procedure to clean the hot water tank if you experience problems:

11. If the machine is in service, remove power from the machine.
12. Dissolve 1 tablespoon of common baking soda in a cup of water.

WARNING

The water tank may be HOT. Be careful when working on the tank.

13. Loosen or remove the hot water tank lid and pour the baking soda solution into the tank.
14. Apply power to the machine.
15. If the tank is not full, fill it.
16. Allow the tank to reach its operating temperature.
17. Leave the solution in the tank for ***AT LEAST*** ½ hour. If possible, leave the solution in the tank for 1 hour.
18. Drain the tank.
19. Refill the tank, then drain again.
20. Refill the tank and put the machine back into service.

THIS PAGE IS INTENTIONALLY LEFT BLANK

APPENDIX D. THE FREE VEND KEYSWITCH OPTION

The free vend keyswitch allows someone to set up free vending without needing to open the door.

NOTE

Freevend Options **MUST** be set to *FREE W/KEY* (see the programming section) for this to work properly.

TO START FREE VEND:

2. Place your key in the free vend keyswitch and turn it to the right. (If the keyswitch is already turned to the right, turn it to the left, then back to the right.) The display shows *ENTER CODE*.
3. Enter the four-digit free vend code. If you enter the wrong code, you have to return to step 2 and start over.
4. If you enter the correct code, the display shows: *FREE ON*.
5. Remove your key. **NOTE:** You don't have to turn the key back to the left to remove it, but it's a good idea to do so.

TO END FREE VEND:

1. Place your key in the free vend keyswitch and turn it to the right. (If the keyswitch is already turned to the right, turn it to the left, then back to the right.) The display shows: *ENTER CODE*.
2. Turn the keyswitch back to the left and remove your key. The display returns to the standby message.

TO ELIMINATE THE CODE REQUIREMENT:

1. The factory default code is 0000. If this code is used, the machine will not ask for a code, but will simply enter freevend mode.
2. To require a CODE entry, change the code to something other than 0000 (see **ENTER A NEW FREEVEND CODE** in the programming section).

NOTE THAT NO CODE IS NECESSARY TO REMOVE THE MACHINE FROM FREE VEND.

THIS PAGE IS INTENTIONALLY LEFT BLANK

This Merchandiser is warranted for one (1) year against defective parts and workmanship. Any part or parts which are proven to be defective within one (1) year of the date of shipment will be repaired or replaced free of charge when the defective part is returned, with transportation charges prepaid, to the destination designated by the National Vendors Warranty Department.

This warranty applies only to the original purchaser of the Merchandiser and is null and void if the Merchandiser is sold during the period of warranty.

This warranty does not apply to a) electrical components, wiring, or circuits and/or for all mechanical parts or assemblies damaged as a result of operating the Merchandiser at other than the design voltage and frequency specified on the Electrical Rating Tag, or b) in event of vandalism, fire or negligence, or c) incandescent lamps, neon lamps, fluorescent lamps, ballasts, starters or other expendable items or d) when other manufactured components are installed in National Vendors Merchandisers.

National Vendors is not responsible for any cost of service rendered or repairs made by customer or its agents on Merchandiser or parts unless authorization to incur such expense has been given in writing by National Vendors prior to incurring such expense.

THIS WARRANTY IS IN LIEU OF ALL OTHER WARRANTIES EXPRESSED OR IMPLIED, INCLUDING WITHOUT LIMITATION, WARRANTIES OF MERCHANTABILITY OR FITNESS FOR A PARTICULAR PURPOSE. NATIONAL VENDORS SHALL NOT BE RESPONSIBLE FOR CONSEQUENTIAL OR PUNITIVE DAMAGES. National Vendors neither assumes nor authorizes any person to assume for it any obligation or liability in connection with the sale of said equipment or any part thereof.